

# DuraTracker<sup>®</sup>

## Installation and Operation Guide



69-4803-032

Revision: D, May 2023

©2022 Teledyne Instruments Incorporated. All rights reserved.

Information included herein is controlled by the Export Administration Regulations (EAR) and requires an export license, license exception or other approval from the appropriate U.S. Government agency before being exported from the United States or provided to any foreign person. Diversion contrary to U.S. law is prohibited.



## Foreword - Water and Wastewater Products

This instruction manual is designed to help you gain a thorough understanding of the operation of the equipment. Teledyne ISCO recommends that you read this manual completely before placing the equipment in service.

Although Teledyne ISCO designs reliability into all equipment, there is always the possibility of a malfunction. This manual may help in diagnosing and repairing the malfunction.

If a problem persists, call or e-mail Teledyne ISCO technical support for assistance. Simple difficulties can often be diagnosed over the phone. For faster service, please have your serial number ready.

If it is necessary to return the equipment to the factory for service, please follow the shipping instructions provided by technical support, including the use of the Return Merchandise Authorization (RMA) specified. Be sure to include a note describing the malfunction. This will aid in the prompt repair and return of the equipment. **No item may be returned for service without a Return Merchandise Authorization (RMA) number issued by Teledyne.**

Teledyne ISCO welcomes suggestions that would improve the information presented in this manual or enhance the operation of the equipment itself.

**Teledyne ISCO is continually improving its products and reserves the right to change product specifications, replacement parts, schematics, and instructions without notice.**

### Contact Information

#### *Customer Service*

Phone: (800) 228-4373 (USA, Canada, Mexico)  
(402) 464-0231 (Outside North America)

Fax: (402) 465-3022

Email: [isco.orders@teledyne.com](mailto:isco.orders@teledyne.com)

#### *Technical Support*

Phone: Toll Free (866) 298-6174 (Samplers and flowmeters)

Email: [iscowatersupport@Teledyne.com](mailto:iscowatersupport@Teledyne.com)

Return  
equipment to: 4700 Superior Street, Lincoln, NE 68504-1398

#### *Other Correspondence*

Mail to: P.O. Box 82531, Lincoln, NE 68501-2531

**Warranty and Operation Manuals can be found on our website at:**

[www.teledyneisco.com](http://www.teledyneisco.com)



*Safety*

Before installing, operating, or maintaining this equipment, it is imperative that all hazards and preventive measures are fully understood. While specific hazards may vary according to location and application, take heed in the following general warnings:

 **WARNING**

**Avoid hazardous practices! If you use this instrument in any way not specified in this manual, the protection provided by the instrument may be impaired.**

 **AVERTISSEMENT**

**Éviter les usages périlleux! Si vous utilisez cet instrument d'une manière autre que celles qui sont spécifiées dans ce manuel, la protection fournie de l'instrument peut être affaiblie; cela augmentera votre risque de blessure.**

*Hazard Severity Levels*

This manual applies *Hazard Severity Levels* to the safety alerts. These three levels are described in the sample alerts below.

 **CAUTION**

Cautions identify a potential hazard, which if not avoided, may result in minor or moderate injury. This category can also warn you of unsafe practices, or conditions that may cause property damage.

 **WARNING**









**Warnings identify a potentially hazardous condition, which if not avoided, could result in death or serious injury.**

 **DANGER**

**DANGER – limited to the most extreme situations to identify an imminent hazard, which if not avoided, will result in death or serious injury.**

*Hazard Symbols*

The equipment and this manual use symbols used to warn of hazards. The symbols are explained in the table below.

<b>Hazard Symbols</b>	
<b>Warnings and Cautions</b>	
	The exclamation point within the triangle is a warning sign alerting you of important instructions in the instrument's technical reference manual.
	The lightning flash and arrowhead within the triangle is a warning sign alerting you of "dangerous voltage" inside the product.
<b>Symboles de sécurité</b>	
	Ce symbole signale l'existence d'instructions importantes relatives au produit dans ce manuel.
	Ce symbole signale la présence d'un danger d'électocution.
<b>Warnungen und Vorsichtshinweise</b>	
	Das Ausrufezeichen in Dreieck ist ein Warnzeichen, das Sie darauf aufmerksam macht, daß wichtige Anleitungen zu diesem Handbuch gehören.
	Der gepfeilte Blitz im Dreieck ist ein Warnzeichen, das Sie vor "gefährlichen Spannungen" im Inneren des Produkts warnt.
<b>Advertencias y Precauciones</b>	
	Esta señal le advierte sobre la importancia de las instrucciones del manual que acompañan a este producto.
	Esta señal alerta sobre la presencia de alto voltaje en el interior del producto.

# DuraTracker®

---

## *Table of Contents*

### **Section 1 Introduction**

---

1.1 Product Description . . . . .	1-1
1.2 Compatible Equipment . . . . .	1-1
1.3 Input Voltage . . . . .	1-2
1.4 Component Identification . . . . .	1-4
1.5 Connector Receptacles . . . . .	1-7
1.6 Maintenance . . . . .	1-7
1.7 Unpacking Instructions . . . . .	1-7
1.8 Technical specifications . . . . .	1-8

### **Section 2 Preparation and Installation**

---

2.1 Overview . . . . .	2-1
2.1.1 Safety . . . . .	2-1
2.2 Modem Installation . . . . .	2-2
2.2.1 SIM Card . . . . .	2-2
2.2.2 Installing the LTE modem . . . . .	2-3
2.2.3 Magnetic-Mount Antenna . . . . .	2-6
2.2.4 Antenna Placement . . . . .	2-6
2.2.5 Modem Frequency Bands . . . . .	2-7
2.2.6 Modem Regulatory Compliance . . . . .	2-7
2.3 Desiccant Inspection . . . . .	2-8
2.4 Communications . . . . .	2-8
2.5 Permanent System Installation . . . . .	2-10
2.6 Portable System Installation . . . . .	2-11
2.7 Using a DuraTracker in Hazardous Location (with Barrier) . . . . .	2-12
2.8 Mounting the DuraTracker . . . . .	2-14
2.8.1 Program the Module . . . . .	2-14
2.9 Final Installation Check . . . . .	2-14

### **Section 3 Programming**

---

3.1 Overview . . . . .	3-1
3.2 Flowlink Help . . . . .	3-1
3.3 Flowlink Connections . . . . .	3-1
3.3.1 USB . . . . .	3-1
3.3.2 Bluetooth . . . . .	3-2
3.3.3 Modem . . . . .	3-5
3.3.4 Remote Updates . . . . .	3-6
3.3.5 Remote Data Retrieval . . . . .	3-6
3.3.6 SMS . . . . .	3-7
3.3.7 Datapush . . . . .	3-7
3.3.8 Check connection . . . . .	3-8
3.4 Configuration . . . . .	3-9
3.4.1 Program Settings . . . . .	3-9
3.4.2 Site Name . . . . .	3-9
3.4.3 Devices . . . . .	3-10
3.4.4 TIENet Setup . . . . .	3-10
3.4.5 Data Storage Settings . . . . .	3-12
3.4.6 Applying Setting Changes . . . . .	3-13

3.4.7 Time Resolution .....	3-13
3.4.8 Rollover Memory .....	3-13

## **Section 4 Modbus Output Protocol**

---

4.1 Overview .....	4-1
4.2 Setup .....	4-1
4.3 Operation .....	4-3
4.3.1 Establishing Communication .....	4-3
4.3.2 Module Addressing .....	4-3
4.3.3 Configurations .....	4-3
4.4 Glossary of Terms .....	4-4
4.5 DuraTracker ASCII or RTU Address .....	4-6
4.6 Register Definitions .....	4-6
4.6.1 Modbus Registers .....	4-6

## **Section 5 Maintenance**

---

5.1 Overview .....	5-1
5.2 Maintenance Kits .....	5-1
5.3 Battery Maintenance .....	5-1
5.3.1 Battery Usage .....	5-1
5.3.2 Battery Usage Examples .....	5-2
5.4 Desiccant Maintenance .....	5-6
5.4.1 Replacing Desiccant .....	5-7
5.4.2 Reactivating Desiccant .....	5-7
5.5 Hydrophobic Filter Maintenance .....	5-8
5.6 Cleaning the DuraTracker .....	5-8
5.7 Servicing the DuraTracker .....	5-9
5.8 Diagnostics .....	5-9

## **Appendix A**

---

A.1 Replacement Parts .....	A-1
A.2 Optional Equipment and Accessories .....	A-1
A.2.1 Cables and Accesories .....	A-1
A.2.2 Battery Options .....	A-1
A.2.3 301 pH/Temperature Device Ending in TIENet Plug .....	A-1
A.2.4 306 Sampler Interface Cable with Connection Ending in TIENet Plug ..	A-2
A.2.5 310 Ex Ultrasonic Level Sensor with Connection Ending in TIENet Plug .....	A-2
A.2.6 360 LaserFlow Velocity Sensor with Connection Ending in TIENet Plug	A-2
A.2.7 360 LaserFlow Ex Velocity Sensor with Connection Ending in TIENet Plug .....	A-3
A.2.8 350 Ex Area Velocity Sensor with Connection Ending in TIENet Plug .....	A-3
A.2.9 Modems .....	A-3
A.3 Company Contact Information .....	A-3
A.3.1 Customer Service Department .....	A-3

## **Appendix B Material Safety Data Sheets**

---

B.1 Safety .....	B-1
------------------	-----

## **List of Figures**

---



1-1 DuraTracker Front	1-4
1-2 DuraTracker Rear	1-5
1-3 DuraTracker w/o Battery Box	1-6
1-4 Capping the connector receptacle	1-7
1-5 Specification Drawing, DuraTracker with Battery Box	1-10
1-6 Specification Drawing, DuraTracker without Battery Box	1-11
2-1 Non-Hazloc Modem	2-2
2-2 Types of SIM cards	2-3
2-3 FCC ID label on modem and location of label on top of DuraTracker case.	2-3
2-4 Screw removal	2-4
2-5 Disconnecting electrical connector and reference line	2-4
2-6 Screw removal	2-4
2-7 Plugging modem into circuit board	2-5
2-8 Connecting antenna cable	2-5
2-9 Installing SIM card	2-5
2-10 Magnetic Mount Antenna	2-6
2-11 Connecting a TIENet sensor cable	2-9
2-12 Power/Modbus Cable	2-10
2-13 Power/Modbus Connections	2-10
2-14 Installation of 6 volt lantern batteries	2-11
2-15 Installation of 1.5 VDC Alkaline D cell batteries	2-12
2-16 Installation of 3.6 VDC Lithium Thionyl Chloride D cell batteries.	2-12
2-17 310 Ex Ultrasonic Sensor	2-13
2-18 350 Ex Area Velocity Sensor	2-13
2-19 360 LaserFlow Ex Sensor	2-13
2-20 360 LaserFlow Ex Sensor with Surcharge Sensor	2-14
3-1 USB installation	3-1
3-2 Flowlink connection screen	3-2
3-3 Flowlink Modem Tab	3-5
3-4 The UpdateSoftware Program.	3-6
3-5 Data tab	3-7
3-6 Manual Data Push	3-8
3-7 301 pH and Temperature Sensor Parameters	3-11
3-8 305 Rain & SDI-12 Input Parameters	3-11
3-9 306 Sampler Interface Parameters	3-11
3-10 310 Ex Ultrasonic Sensor Parameters	3-11
3-11 350 Ex Area Velocity Sensor Parameters	3-11
3-12 360 LaserFlow Sensor Parameters	3-12
3-13 360 LaserFlow Ex Sensor Parameters	3-12
3-14 Data Storage Setup window	3-13
4-1 Screw removal	4-2
4-2 Disconnecting electrical connector and reference line	4-2
4-3 Jumper position	4-2
4-4 Configuration example	4-4
5-1 Desiccant cartridge locations	5-6
5-2 Removal of Desiccant Cartridge Cap	5-7
5-3 Replacing the hydrophobic filter	5-8
5-4 Retrieving diagnostic files manually	5-9
5-5 Retrieving diagnostic files automatically	5-10

## List of Tables

---

1-1 DuraTracker Battery Options	1-3
1-2 DuraTracker Components - Front View	1-4
1-3 DuraTracker Components - Rear View	1-5
1-4 DuraTracker w/o Battery Box Components	1-6

1-5 DuraTracker Flow Meter Technical Specifications ..... 1-8  
2-1 Modem Frequency Bands ..... 2-7  
2-2 Power/Modbus Connections ..... 2-10  
3-1 Site Window Tabs ..... 3-9  
3-2 Invalid Characters ..... 3-9  
4-1 Modbus Terms ..... 4-5

# DuraTracker®

---

## *Section 1 Introduction*

### **1.1 Product Description**

The DuraTracker flow logger and the attachable TIENet™ devices are designed for open channel flow monitoring applications. It has built-in standard level-to-flow conversions that cover the majority of open channel flow measurement situations. Flow measurement is a calculation based on a known relationship between liquid level and flow rate. Additionally, the DuraTracker can calculate flow using standard open channel level-to-flow and area-velocity conversions, including equations and data points, depending on the measurement device(s) attached to the meter and the program specified by the user.

The DuraTracker's data storage memory can store measurement in intervals ranging from 15 seconds to 24 hours. It can also be configured for variable rate data storage to enable storage at differing intervals depending on the occurrence of programmed conditions. DuraTracker's program and collected data are stored on a flash memory microSD card for security. This retains data without the concern of power failures. The memory capacity of a microSD card is more than sufficient for most applications. For example, flash memory is capable of storing approximately 1.3 million readings — the equivalent of over 2700 days with 5 parameters at 15 minute intervals, reports once per day. Flash memory also stores instrument configuration and sensor calibration information.

The DuraTracker is programmed with Teledyne ISCO's Flowlink® software. Flowlink quickly configures the DuraTracker, retrieves measurement data, manages site information, and analyzes data.

DuraTracker's components are rated IP68. Its gasket-sealed enclosures are designed to meet the environmental demands of sewer flow monitoring applications. All connections between the DuraTracker's antenna and sensors lock in place. This locking mechanism secures the components and provides a watertight seal.

### **1.2 Compatible Equipment**

A basic DuraTracker system consists of two TIENet devices for flow and/or parameter measurement connected to the DuraTracker flowmeter. Other configurations may include an enclosure and additional internal or external devices. DuraTracker flowmeters can interface with a variety of measurement devices and other system components. Compatible flow measurement technologies include the TIENet 350 Continuous Wave Doppler Sensor, the TIENet 310 Ex Ultrasonic Level Sensor, and the TIENet 360 LaserFlow Sensor. Other compatible devices include the TIENet 301 pH & Temp Sensor, and the TIENet 306

Sampler Interface. Four measurement devices for flow and water quality can be connected to the same DuraTracker and run simultaneously with TIENet connectivity. (See Section 3.4.3 for combinations that can be used.)

 **Note**

For details on a TIENet sensor, refer to the user manual for that device.

For descriptions of interfacing and parameter-sensing TIENet devices, refer to Sections 2 and 3. Each external TIENet device comes with an individual user manual.

A variety of application-specific accessories are available from Teledyne ISCO. Refer to Appendix A.2 for a complete list of accessories and ordering information.

### 1.3 Input Voltage

The DuraTracker power system's voltage measurement is used when estimating the remaining battery life and determining routine servicing. The voltage readings can be logged in data storage to chart power consumption.

The DuraTracker has two battery compartments that power the unit. Only one battery compartment is needed to run the unit. If both battery compartments are used, the DuraTracker will deplete the batteries in one compartment first before switching to the other battery compartment.<sup>1</sup>

 **Note**

360 LaserFlow battery banks will run in parallel at all times. It is recommended to use both banks of batteries when running a 360 LaserFlow.

The DuraTracker also has the option of using external power supplied through the Power/Modbus cable. When power is detected at the external source, the DuraTracker will always use that source.

---

1. See Section 5.3.1 *Battery Usage* for further information about battery bank-switching behavior.

**Table 1-1 DuraTracker Battery Options**

6 VDC Alkaline Lantern Battery Rayovac 808	Requires two batteries in one bank to operate. An additional two batteries can be used to extend life.	Battery: 340406000 Holder: 604804025 (comes with two)
1.5 VDC Alkaline D Cell Battery	Requires eight batteries in one bank to operate. An additional eight batteries can be used to extend life. A HazLoc D cell battery holder can be ordered from Teledyne ISCO.	Holder: 604804024
3.6 VDC Spiral Wound Lithium Thionyl Chloride D Cell Battery (non- Rechargeable)	Requires four batteries. An additional four can be used to extend life. A custom Lithium D cell battery holder can be ordered from Teledyne ISCO.	Battery: 340903600 Holder: 604804026

## 1.4 Component Identification

The components of the DuraTracker are shown in Figure 1-1, Figure 1-2 and Figure 1-3. Items referenced in those figures are summarized in Table 1-2, Table 1-3, and Table 1-4.

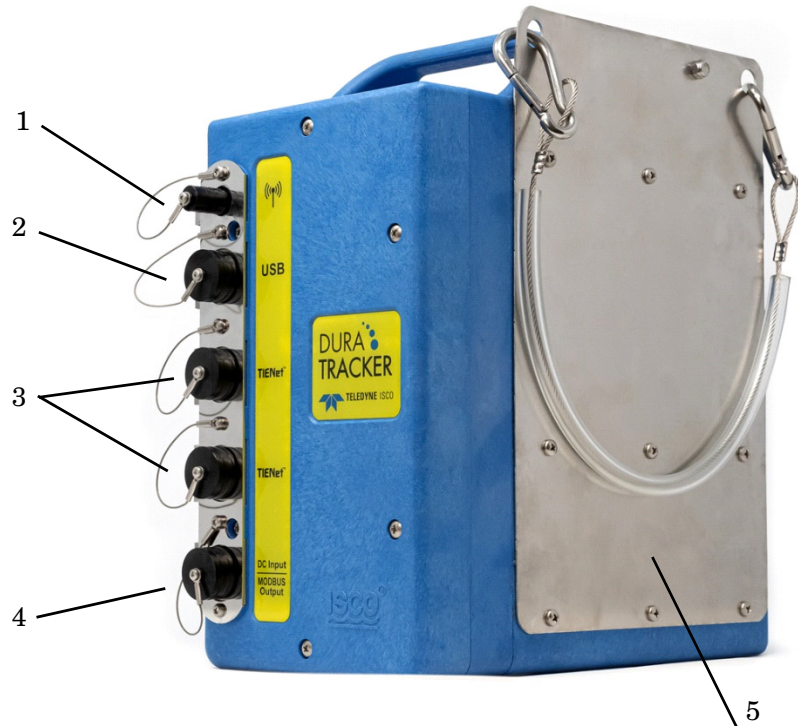

Figure 1-1 DuraTracker Front

Table 1-2 DuraTracker Components - Front View		
Item No.	Name	Description
1	Antenna Connector	Used to connect the modem to the antenna
2	USB Connector	The USB connector is used to connect the DuraTracker to a computer using a USB cable
3	TIENet Connector	Used to connect the DuraTracker to compatible TIENet equipment
4	Power/Modbus Connector	Used to connect the DuraTracker to external power and Modbus
5	Hanging Bracket	Used to hang the DuraTracker



Figure 1-2 DuraTracker Rear

Table 1-3 DuraTracker Components - Rear View		
Item No.	Name	Description
1	Battery Cap Bank 1	Used to secure the battery in the DuraTracker
2	Desiccant Cap (reference air and electronics)	Used to secure the desiccant for the reference air and electronics housing in the DuraTracker
3	Antenna Mount Bracket (optional)	Used to locate the antenna on the DuraTracker
4	Desiccant Cap (battery box)	Used to secure the desiccant for the battery box in the DuraTracker
5	Battery Cap Bank 2	Used to secure the battery in the DuraTracker



Figure 1-3 DuraTracker w/o Battery Box

Table 1-4 DuraTracker w/o Battery Box Components		
Item No.	Name	Description
1	Antenna Connector	Used to connect the modem to the antenna
2	USB Connector	The USB connector is used to connect the DuraTracker to a computer using a USB cable
3	TIENet Connector	Used to connect the DuraTracker to compatible TIENet equipment
4	Power/Modbus Connector	Used to connect the DuraTracker to external power and Modbus
5	Antenna Mount Bracket (optional)	Used to locate the antenna on the DuraTracker
6	Hanging Bracket	Used to hang the DuraTracker
7	Desiccant Canister	Used to hold desiccant for the reference air and electronics housing in the DuraTracker



## 1.5 Connector Receptacles

Any connector receptacle not in use should always be capped. The cap seals the connector in order to prevent moisture from entering the unit and corrosion from occurring.

### **Note**

Caps push on and pull off. Do not rotate the caps to remove them from the connectors. Always push caps into the receptacle until you hear an audible click. The click occurs when the latch locks the cap in place.

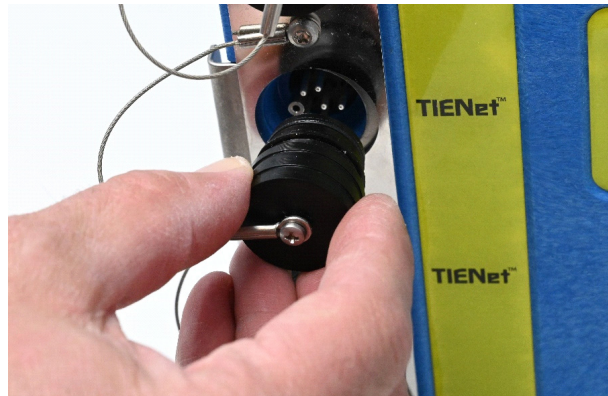

Figure 1-4 Capping the connector receptacle

## 1.6 Maintenance

The DuraTracker is designed to provide durable operation with minimal routine maintenance. All maintenance can be performed in the field. Typically, maintenance consists solely of the replacement of desiccant and batteries. See Section 5 for more details.

## 1.7 Unpacking Instructions

When the system arrives, inspect the outside packaging for any damage. Then, carefully inspect the contents of the package for damage.

### **WARNING**

**If there is any evidence that items may have been damaged in shipping, do not attempt to install the unit. Contact Teledyne ISCO immediately.**

When unpacking the system, check the contents with the included packing list. If any parts are missing, contact Teledyne ISCO's Customer Service Department. Contact information for Teledyne ISCO's Customer Service Department can be found in Appendix A.3.1. Please report missing part(s) by part number. In addition to the primary packing list, there may be secondary packing lists for various sub-components. It is recommended that you retain the shipping cartons, as they can be used to return the unit to Teledyne ISCO if necessary.

Please complete the registration card for the unit and return it to Teledyne ISCO.

## 1.8 Technical specifications

Table 1-5 DuraTracker Flow Meter Technical Specifications					
Size (HxWxD) DuraTracker DuraTracker w/o Battery Box	12.25 x 6.25 x 12.75 in (31.12 x 15.88 x 32.39 cm) 13.375 x 8.625 x 4.5 in (33.97 x 21.91 x 11.43 cm)				
Weight DuraTracker  DuraTracker w/o Battery box	14.3 lbs. (6.49 kg) without batteries  5.3 lbs. (2.4 kg)				
Enclosure	IP68 (self certified)				
Power DuraTracker	9-15 VDC				
External Power (DuraTracker Ex does not have external power)	7-28 VDC				
Operating Temperature DuraTracker	-40° to 140 °F (-40° to 60 °C)				
Storage Temperature	-40 to 140 °F (-40 to 60 °C)				
Typical Battery Life			310 Ex Ultrasonic sensor	350 Ex AV Sensor	360 Ex LaserFlow sensor
	DuraTracker with*	2 x 6V Rayovac 808 Batteries	18 months	8 months	9.4 months
		D Cell Batteries	13.5 months	6 months	7 months
Data Storage	Non-volatile flash; retains stored data during program updates. Capacity 8 MB (1.3 million readings or 2700 days with 5 parameters logged at 15 minute intervals, reports once per day)				
Storage mode	Rollover, 5 bytes per reading				
Storage Interval	15 or 30 seconds; 1, 2, 5, 15 or 30 minutes; or 1, 2, 4, 12 or 24 hours. Storage rate variable based on measurement parameters				
Data Types	Flow Rate, Level, Temperature, Velocity, Volume, Input Voltage, Wireless Signal				

Flow Measurement Technologies	Ultrasonic (TIENet 310 Ex) Continuous Wave Doppler Velocity (TIENet 350) Laser Doppler Velocity TIENet 360 LaserFlow)
Flow Conversions	Weir, Flume, British Flume, Metering Insert, Manning Formula, Equation, LTF or LTA Data Points (up to 50 pairs), Area Velocity
Industry Standard Outputs	RS485 Modbus ASCII and RTU
Communication Options	Direct USB Serial Connection, 4G LTE Modem, Bluetooth

\*Actual battery life will vary depending on configuration. The figure given assumes interrogation on site with Flowlink once a week, with a site configuration as indicated and using one bank of batteries (two banks of batteries will double the battery life). The DuraTracker was configured to record level, velocity and flow rate every 15 minutes; total flow and battery voltage every 24 hours. No modem or Bluetooth connectivity.

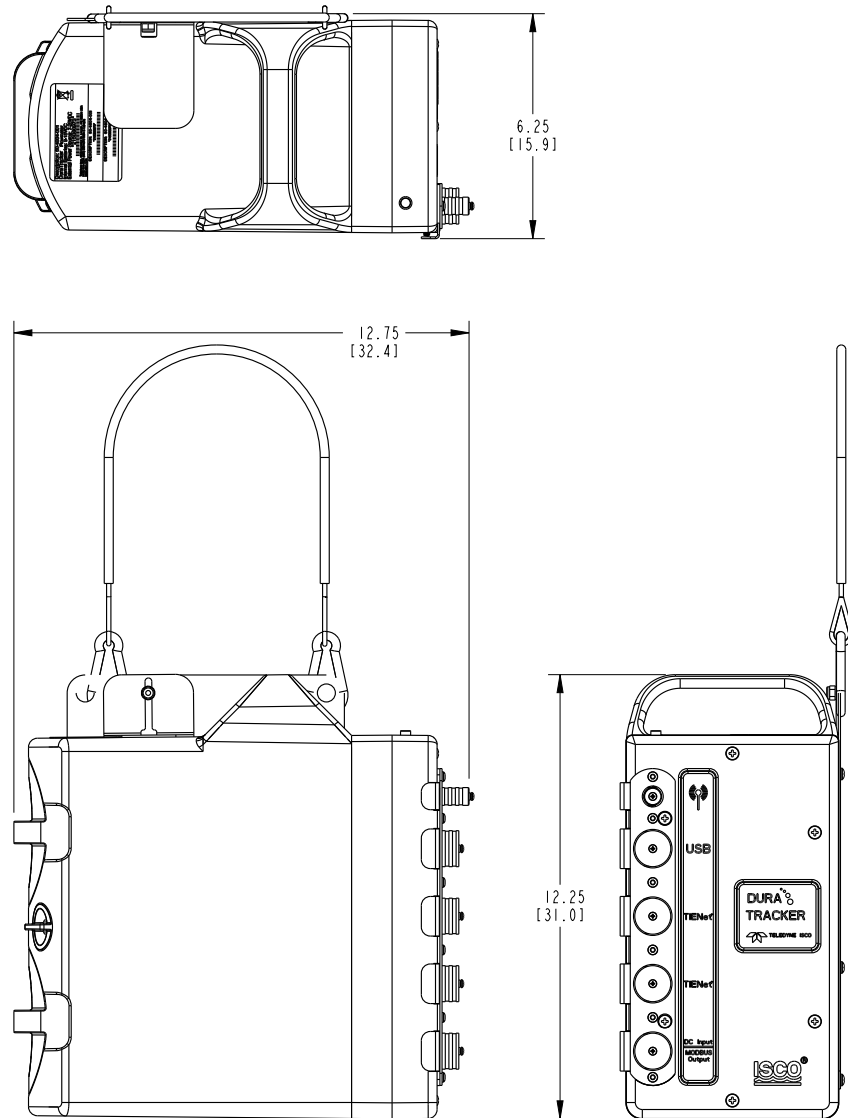

Figure 1-5 Specification Drawing, DuraTracker with Battery Box

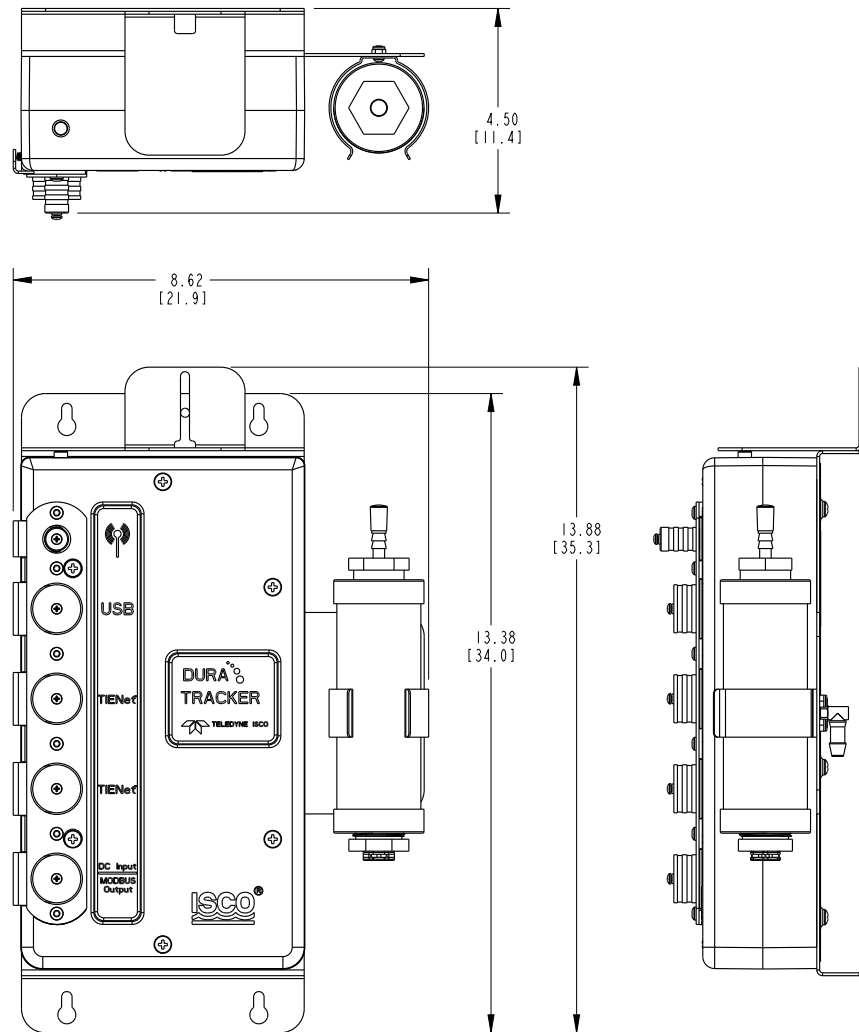

Figure 1-6 Specification Drawing, DuraTracker without Battery Box



# DuraTracker®

## Section 2 Preparation and Installation

### 2.1 Overview

The section covers preparation instructions for the installation of the DuraTracker and is not for the DuraTracker Ex.

The DuraTracker flow meter may be installed as a permanent or as a portable system. Permanent systems are powered by the power input cable as described in Section 2.5. Portable systems are powered by battery power as described in Section 2.6.

#### **WARNING**

**Avoid hazardous practices! If you use these instruments in any way not specified in this manual, the protection provided by the instruments may be impaired. This will increase your risk of injury.**

#### 2.1.1 Safety

Before installing, operating, or maintaining the equipment, it is imperative that all hazards and preventative measures are fully understood.

##### *Site Conditions*

The DuraTracker components are often installed in confined spaces. Examples of confined spaces include manholes, pipelines, digesters, and storage tanks. These spaces may become hazardous environments that can prove fatal for those unprepared. In the United States, these spaces are governed by OSHA 1910.146 and require a permit before entering. For areas outside of the United States, adhere to local laws and safety regulations concerning confined space entry.

#### **WARNING**

**The installation and use of this product may subject you to hazardous working conditions that can cause you serious harm or fatal injuries. Take any necessary precautions before entering a worksite. Install and operate this product in accordance with all applicable safety and health regulations, and local ordinances.**

##### *Mounting Considerations*

Ideal installation sites for the DuraTracker are easily accessible for service and data collection while still providing protection for the device. The DuraTracker is constructed of materials that can withstand hard environments. However, continual exposure to UV light or periodic submersion should be avoided in order to extend the life of the components.

Typically, the DuraTracker is suspended inside a manhole. Suspending it near the opening will protect it from the elements, minimize the chance of submersion, and allow it to be easily retrieved without entering the manhole.

### System Power

The maximum voltage for the DuraTracker is 15 V in the battery compartment and 28 V from the external power plug.

**⚠ WARNING**

**Injury and/or equipment damage can result from attempting to connect a DuraTracker to a system using a power source that exceeds the specified operating voltage range. Check labeling on all units and cables for voltage ranges.**

## 2.2 Modem Installation

The Long Term Evolution (LTE) modems can automatically push data to a secure server running ISCO Flowlink Pro software. With LTE data transmission, your service parameters or provider can be changed by replacing the removable Subscriber Information Module (SIM) card in your modem. There is one modem for North America and one for Europe.



Figure 2-1 Non-Hazloc Modem

### 2.2.1 SIM Card

The data transmission capabilities of the LTE modems are dependent upon the type of service plan you have through your cell phone service provider. The service parameters, or provider, can be changed by simply replacing the SIM card in your modem. Check with your service provider to verify which data transmission technologies are available for your use. There are three types of SIM cards, but only Micro SIM cards will work in the LTE modems.

**☑ Note**

A Micro SIM card is required for any LTE units including the DuraTracker modems.



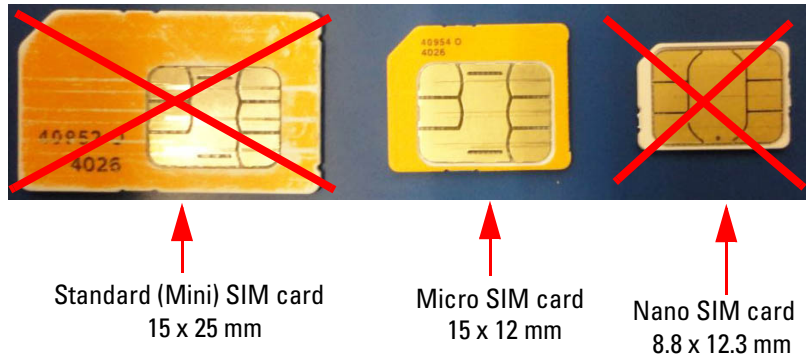

Figure 2-2 Types of SIM cards

**Note**

If you are using Verizon and want to be able to text the modem, you MUST use Verizon SIM card P/N BULKSIM-TRI-A or Nimbink SIM card P/N NL-SIM-COM due to Verizon LTE network not having fallback to 2G/3G.

### 2.2.2 Installing the LTE modem

The modem kit includes the modem, antenna, and antenna bracket with hardware.

**Note**

Before installing the modem, remove the top label (with the FCC ID and IMEI number on it) taped to the modem and adhere it to the outside of the DuraTracker case on the top of the unit, next to the antenna bracket (See Figure 2-3). This is required by the FCC and ensures the IMEI number is visible.

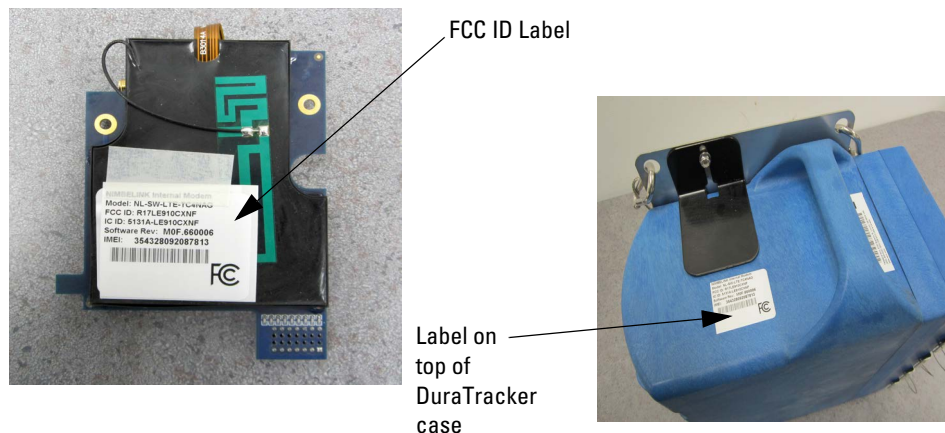

Figure 2-3 FCC ID label on modem and location of label on top of DuraTracker case.

**Note**

The DuraTracker modem will not work in the DuraTracker Ex.

1. Remove batteries from DuraTracker and open the front electronics panel by removing the six screws on the front of the unit. Before opening the case, make sure you are grounded so that you do not damage the internal components with an Electrostatic Discharge (ESD).



Figure 2-4 Screw removal

**⚠ CAUTION**

If case is opened to install a modem, change a SIM card, or set up Modbus, ESD protection must be observed. Failing to do so could result in damage to the DuraTracker.

2. Open the case and disconnect the electrical connector and reference line from the battery box.

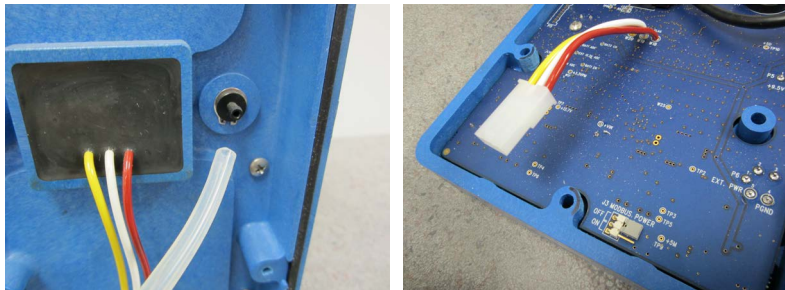

Figure 2-5 Disconnecting electrical connector and reference line

3. Remove the two screws from the upper left section of the DuraTracker case and set them aside to reuse.

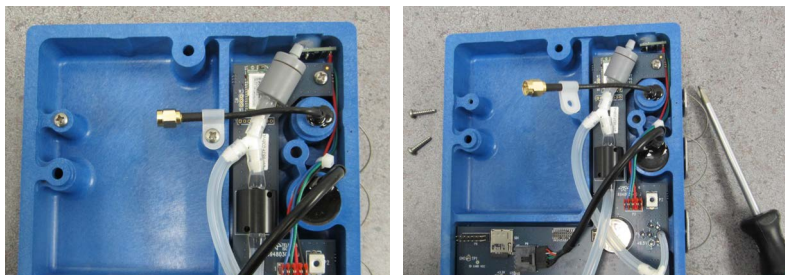

Figure 2-6 Screw removal

4. Connect the new modem to the circuit board by lining up the connectors and pushing the board all the way down.



Figure 2-7 Plugging modem into circuit board

5. Reinstall the two screws that were removed in step 3 through the modem to hold it in place.
6. Connect the antenna connector to the modem and tighten all the way down.



Figure 2-8 Connecting antenna cable

7. Install the SIM card in the SIM card holder with the notch facing out.



Figure 2-9 Installing SIM card

8. Line up the two halves of the case, being careful to make sure the wires from the electrical connector do not get pinched between the two halves.

9. Reattach the front panel with the O-ring screws removed in step 1. When starting screws in plastic, you should always start turning them counterclockwise until you feel/hear the audible click of the threads lining up. Once the threads line up you can turn the screw clockwise to tighten it down. This will ensure you do not cross-thread the plastic holes.

 **Note**

Do not install screws using power tools. Use only hand tools

10. Install antenna bracket to the hanging bracket using the included hardware.

### 2.2.3 Magnetic-Mount Antenna

The magnetic -mount antenna, included with LTE modems, has a 10-foot cable and a white connector indicating that it is suitable for LTE use. This antenna is for general use and is especially desirable when the system is housed within an enclosure.



Figure 2-10 Magnetic Mount Antenna

 **Note**

When any communications connector is not in use, it should always be capped. The cap will seal the connector to prevent corrosion, prevent moisture from entering the unit, and improve communications.

### 2.2.4 Antenna Placement

1. The antenna needs to be placed in vertical orientation. It does **NOT** radiate out of the ends of the antenna.



2. The best performance will be with the antenna placed on a large metal ground plane, above ground and without large obstructions between the antenna and the tower. This is not always possible but in instances where signal strength is low, this may be necessary.
3. Any metal surrounding the antenna will degrade performance! Placing the antenna 4" to 8" lower than the metal ring the manhole cover sits on will provide better signal quality. Dirt and concrete lower signal strength less than metals which cause the signal to attenuate.

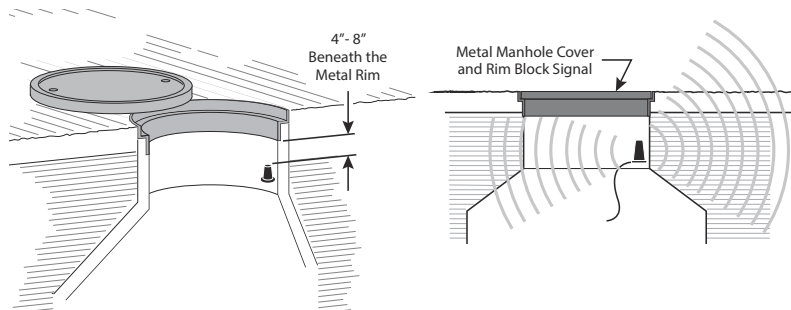

4. **Do NOT kink the coax!** The coaxial cable that feeds the antenna should never be in a loop tighter than the size of a fist. A coax that has been kinked will degrade the signal even after being straightened back out.
5. Antennas near strong radio towers or other sources of RF interference can jam the signal even though it is on a different frequency.

### 2.2.5 Modem Frequency Bands

Table 2-1 Modem Frequency Bands					
ISCO Part Number	Type	4G LTE Bands	Fallback	Applicable Networks	Location
604807013	Cat 4	LTE-FDD: B2, B4, B5, B12, B13, B14, B66, B71	3G HSPA+: B2, B4, B5	AT&T, Verizon, Bell Telus and Rogers	North America and others, depending on supported bands
604807014	Cat 4	LTE-FDD: B1, B3, B7, B8, B20	3G: B1, B8 2G: GSM 900, DCS 1800	Orange, Telstra, Telus, Vodafone and More	Europe and others, depending on supported bands

### 2.2.6 Modem Regulatory Compliance

#### United States

Device Uses Approved Radio: NL-SW-LTE-TC4NAG  
 Contains FCC ID: R17LE910CXNF  
 Contains IC: 5131A-LE910CXNF

This device complies with Part 15 of the FCC Rules and Industry Canada license-exempt RSS standards. Operation is subject to the following two conditions: (1) This device may not cause

harmful interference, and (2) this device must accept any interference received, including interference that may cause undesired operation.

### Europe

This device has been Radio Equipment Directive tested and complies with EN 55011:2016/A1:2017/A11:2020 and EN 61326-1:2013.



## 2.3 Desiccant Inspection

Two desiccant cartridges are inserted into the battery compartment of the DuraTracker. The cartridges are filled with silica gel beads that will indicate when they are saturated. Under dry conditions, the beads are orange in color. As the desiccant becomes saturated, the beads turn green. If the entire length of the desiccant cartridge turns green, the unit is no longer adequately protected. Replace the desiccant before the entire length of the desiccant cartridge turns green. Refer to Section 5.4 for instructions on how to replace the desiccant cartridge.

Inspect the color of the desiccant before deploying the unit or whenever on site. If monitoring the site remotely, periodically inspect the reference line humidity levels. If this level reaches an abnormally high humidity, visit the site to inspect the desiccant.

## 2.4 Communications

The DuraTracker is accessed for configuration and data retrieval using Flowlink software. Connections between a PC and the DuraTracker can be made using a USB cable, Bluetooth®, or via an IP address with a cellular modem. With Flowlink, you can name the site, set up its operation, adjust the level measurement technologies, and retrieve stored measurements. To assist with servicing, Flowlink will display input power voltage (indicating remaining battery life) and collect diagnostic reports.

 <b>Note</b>
---

To ensure protection of the unit, unused communication ports must be capped.

### *TIENet Connections*

The DuraTracker has two TIENet receptacles located on the front of the unit. Sensor cables are attached to these receptacles. To connect the sensor:

1. Remove the protective caps.
  - a. Push down on the sensor release while pulling the protective cap from the TIENet receptacle.
  - b. Pull the cap from the end of the sensor cable plug.
2. Prepare the TIENet plug.

- a. Inspect the plug. It should be clean and dry. Damaged O-rings must be replaced. Spare O-rings are supplied in the maintenance kit.
- b. Coat the O-ring's sealing surface with a silicone lubricant.

**⚠ CAUTION**

Do not use petroleum-based lubricants. Petroleum-based lubricants will cause the O-ring to swell and prematurely deteriorate. Aerosol silicone lubricant sprays often use petroleum-based propellants. If using an aerosol spray, allow the propellant to evaporate for several minutes before proceeding.

**⚠ CAUTION**

Only plug sensors into the DuraTracker when power has been removed. Failure to do so could result in damage to the DuraTracker.

3. Insert the TIENet plug into the receptacle. The sensor release will click when the sensor cable is properly connected.
4. Connect the two caps.



*Figure 2-11 Connecting a TIENet sensor cable*

### *Modbus Output Device*

The Modbus RS-485 output function enables a SCADA system to retrieve site data from the logger. The connection to a Modbus output device is achieved through the Power/Modbus Cable (ISCO P/N 604804023) shown in Figure 2-12 below. Connection information can be found in Figure 2-13 and Table 2-2.

For Modbus register numbers and definitions, as well as a general explanation of Modbus output protocol, refer to Section 4.

## 2.5 Permanent System Installation

The DuraTracker front panel has a DC Input/Modbus Output connector port that can provide power to the unit. When power is provided via the DC Input, it will take precedence over the batteries as long as the DC Input power is higher than the batteries. Otherwise it will run on battery power until the battery bank in use is lower than the DC Input power. If batteries are installed, they will only be used in case the external power is removed or goes out. A Power/Modbus cable (ISCO Part# 604804023) is available from Teledyne ISCO customer service. The Power/Modbus cable plugs into the front panel of the DuraTracker and provides a watertight seal. The Power/Modbus cable can be used to supply up to 28 VDC to the DuraTracker.



Figure 2-12 Power / Modbus Cable

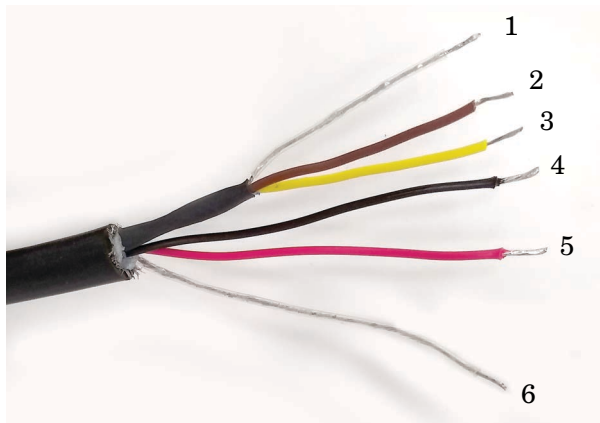

Figure 2-13 Power / Modbus Connections

Table 2-2 Power/Modbus Connections		
Item No.	Name	Description
1	Shield	Tied to Ground
2	Brown	D0 (-)
3	Yellow	D1 (+)
4	Black	Ground



5	Red	Positive
6	Braid-Drain	Earth Ground

## 2.6 Portable System Installation

The DuraTracker battery compartment has two banks for batteries. Each bank can provide power to the unit independently of the other bank. The DuraTracker can use a variety of battery options as detailed in Table 1-1. The figures below show the installation procedure for each of these battery options.

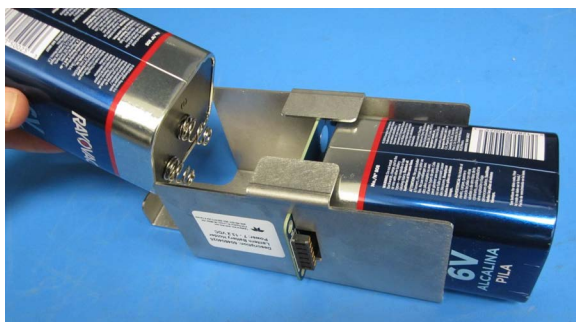

*Figure 2-14 Installation of 6 volt lantern batteries*



Figure 2-15 Installation of 1.5 VDC Alkaline D cell batteries



Figure 2-16 Installation of 3.6 VDC Lithium Thionyl Chloride D cell batteries.

**⚠ WARNING**

**Never mix old and new batteries. Never mix different types of batteries.**

### 2.7 Using a DuraTracker in Hazardous Location (with Barrier)

The DuraTracker may be used in a Hazardous location if a Teledyne ISCO Barrier (ISCO P/N 604364112) is used to connect to the sensor. The Barrier must be set up following its control drawing (see the TIENet Barrier manual for details). When

using a 350 Ex, a Ex Reference Air Box must be used (see the 350 Ex manual for details). See the following diagrams for maximum cable lengths and configurations for Hazardous locations when using a DuraTracker and Barrier.

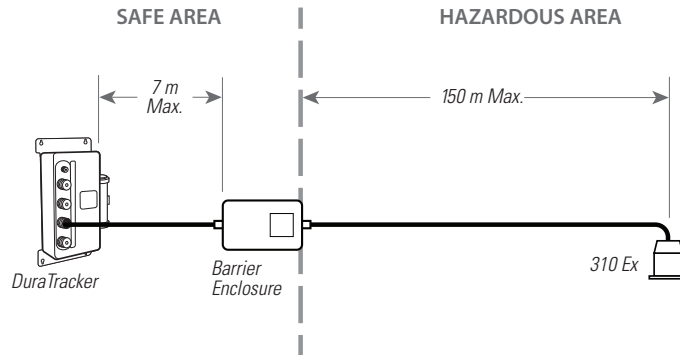

Figure 2-17 310 Ex Ultrasonic Sensor

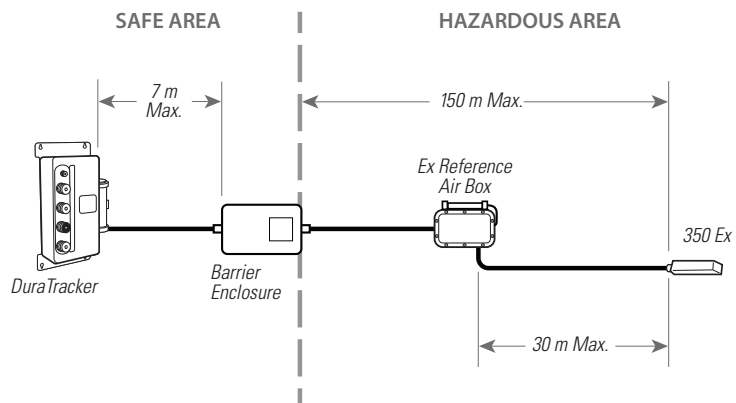

Figure 2-18 350 Ex Area Velocity Sensor

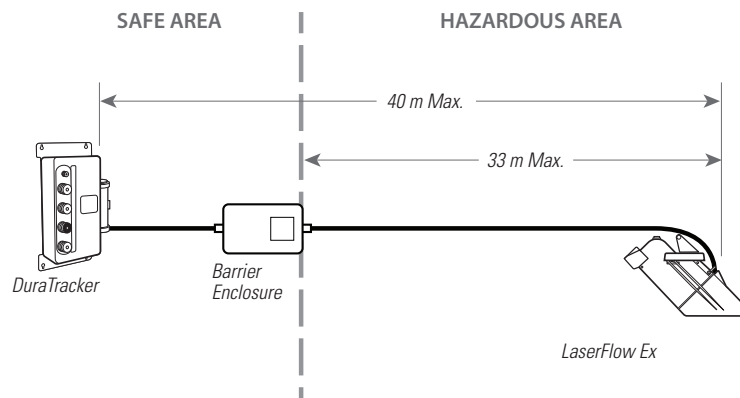

Figure 2-19 360 LaserFlow Ex Sensor

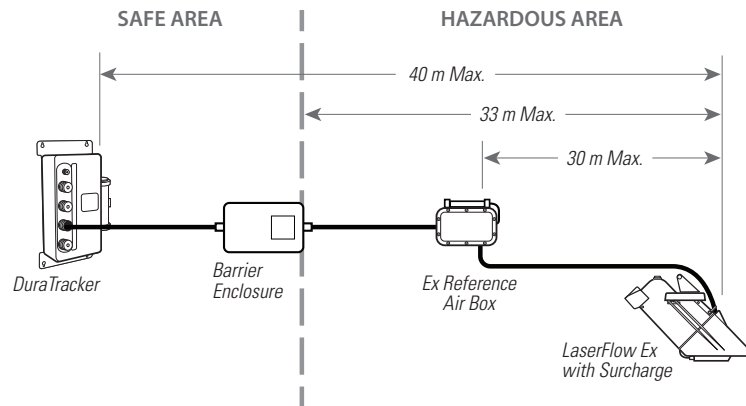

Figure 2-20 360 LaserFlow Ex Sensor with Surchage  
Sensor

## 2.8 Mounting the DuraTracker

### Site Examples

The DuraTracker is designed to monitor flow in open channels. The unit should be secured at the site. This prevents damage caused by accidental falls and from being swept away if the channel is flooded. A typical installation involves having the logger suspended from a manhole ladder or other support. Other options include the use of a spreader bar. Teledyne ISCO's Product Support Services Group or your local representative can assist you with installation options.

Additionally, there will need to be a selection made as to the appropriate mounting hardware for the TIENet sensor.

### 2.8.1 Program the Module

After you have installed the Sensor, the flow stream properties must be defined. To do this, connect to the DuraTracker with Flowlink for Windows software and define the stream properties in the DuraTracker's program settings. These ensure that the system correctly reads the liquid level and converts the measured level to flow rate.

#### **Note**

The DuraTracker requires Flowlink 5.19 or later. Earlier versions do not support the DuraTracker.

## 2.9 Final Installation Check

**Basic Installation Checklist** - As a review, the following steps may be used as a guide to install a DuraTracker at a basic site.

1. Install the TIENet Sensor per the sensor manual.
2. Attach the TIENet Sensor cable to the DuraTracker.
3. Prepare the Battery Box.
  - a. Install batteries.
  - b. Inspect desiccant.
4. Connect to the site with Flowlink Software
  - a. Create the site by Quick Connecting to the modules.

- b. Set up the site and DuraTracker settings.
  - c. Calibrate the level measurement.
5. Disconnect from the site and replace all protective caps.
  6. Mount or suspend the DuraTracker.

 **CAUTION**

Only plug sensors into the DuraTracker when power has been removed. Failure to do so could result in damage to the DuraTracker.



# DuraTracker®

## Section 3 Programming

### 3.1 Overview

This section describes how to set up the operation parameters for the DuraTracker using Teledyne ISCO's Flowlink software.

### 3.2 Flowlink Help

This user manual contains basic Flowlink help and procedures. Detailed Flowlink instructions are available in Windows Help format. You can access the help topics for an active window within Flowlink by clicking on the Help button or by pressing F1 on your computer's keyboard. You can also access Help from the Flowlink menu by selecting HELP > CONTENTS AND INDEX. These instructions are provided within the Flowlink software user manual.

### 3.3 Flowlink Connections

Initial connection to the DuraTracker is made directly between a PC and the unit using a USB connection cable or Bluetooth connection and Teledyne ISCO's Flowlink software. After the initial connection and setup of the modem, subsequent connections can also be made via a modem connection (IP).

#### 3.3.1 USB

Push the lock release on the port labeled USB and pull the cap off the front panel without twisting the cap. Plug the USB B male connector into the port on the DuraTracker and the USB A male to a PC of the connection cable. The DuraTracker is now ready to be logged into via Flowlink software.



Figure 3-1 USB installation

### 3.3.2 Bluetooth

#### *Enabling Bluetooth*

In order to connect to a DuraTracker unit via Bluetooth, the Bluetooth module on the unit must first be powered. To do this, the user may connect to the DuraTracker unit with Flowlink and define a Bluetooth control schedule from the Wireless Power Control tab. (Setting the Bluetooth control schedule will affect battery life.) Alternatively, power cycling the DuraTracker unit by removing all batteries for 60 seconds and then reinstalling them will enable Bluetooth for a 20 minute duration after power is applied to the unit.

If the DuraTracker has a modem and it has been set up already, you can text the word “Bluetooth” to the phone number and the DuraTracker will text back and open a 20 minute window once the text has been read by the unit. The SMS checking interval is set in Flowlink, but the default is 1 hour (at the top of every hour.) Setting the SMS check interval to less than 1 hour will affect battery life.

Once the DuraTracker Bluetooth module is powered, you can connect your device with the DuraTracker. Anytime the Bluetooth is actively powered, the LED on top of the unit will flash blue around once every 3 seconds.

#### *Establishing a Bluetooth connection from Flowlink*

Open Flowlink and access the Connect window. Select BLUETOOTH for connection type and click on the DISCOVER button. Once the DuraTracker is discovered it will show up in the drop-down list. Select your DuraTracker and click on the DuraTracker connection button. Flowlink will proceed to connect to your DuraTracker.

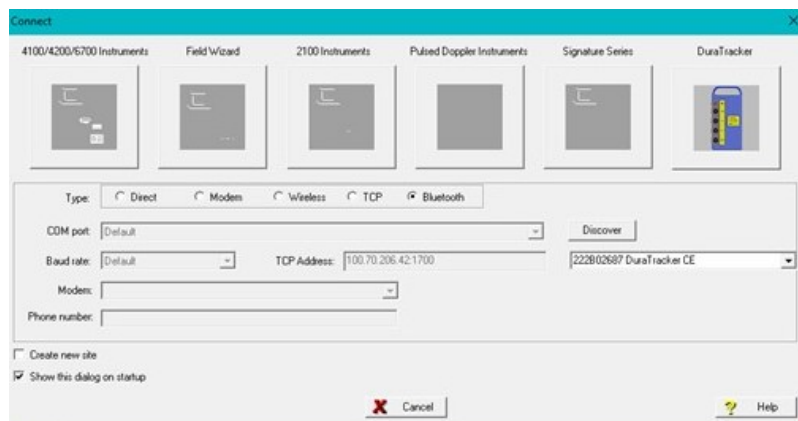

Figure 3-2 Flowlink connection screen

#### *Establishing a Bluetooth connection from a terminal emulator*

With a terminal emulator program, select the COM port corresponding to the DuraTracker unit, and use the following serial line settings:



- Speed: [doesn't matter]
- Data bits: 8
- Stop bits: 1
- Parity: none
- Flow control: none

### *Regulatory Approval*

#### **United States**

This equipment has been tested and found to comply with the limits for a Class B digital device, pursuant to part 15 of the FCC Rules. These limits are designed to provide reasonable protection against harmful interference in a residential installation. This equipment generates, uses and can radiate radio frequency energy, and if not installed and used in accordance with the instructions, may cause harmful interference to radio communications. However, there is no guarantee that interference will not occur in a particular installation. If this equipment does cause harmful interference to radio or television reception, which can be determined by turning the equipment off and on, the user is encouraged to try to correct the interference by one or more of the following measures:

- Reorient or relocate the receiving antenna.
- Increase the separation between the equipment and receiver.
- Connect the equipment into an outlet on a circuit different from that to which the receiver is connected.
- Consult the dealer or an experienced radio/TV technician for help.

#### **Canada**

This device contains license-exempt transmitter(s)/ receiver(s) that comply with Innovation, Science and Economic Development Canada's license-exempt RSS(s). Operation is subject to the following two conditions:

1. This device may not cause interference;
2. This device must accept any interference, including interference that may cause undesired operation of the device.

L'émetteur/récepteur exempt de licence contenu dans le présent appareil est conforme aux CNR d'Innovation, Sciences et Développement économique Canada applicables aux appareils radio exempts de licence. L'exploitation est autorisée aux deux conditions suivantes:

1. L'appareil ne doit pas produire de brouillage;
2. L'appareil doit accepter tout brouillage radioélectrique subi, même si le brouillage est susceptible d'en compromettre le fonctionnement.

### Europe

This device has been Radio Equipment Directive tested and complies with EN 55011:2016/A1:2017/A11:2020 and EN 61326-1:2013.



### Japan



### Korea

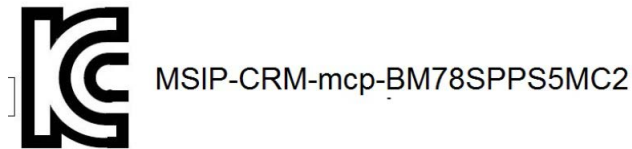

### Taiwan



#### 注意！

依據 低功率電波輻射性電機管理辦法

第十二條 經型式認證合格之低功率射頻電機，非經許可，

公司、商號或使用者均不得擅自變更頻率、加大功率或變更原設計

之特性及功能。

第十四條 低功率射頻電機之使用不得影響飛航安全及干擾合法通信；

經發現有干擾現象時，應立即停用，並改善至無干擾時方得繼續使用。

前項合法通信，指依電信規定作業之無線電信。

低功率射頻電機須忍受合法通信或工業、科學及醫療用電波輻射性

電機設備之干擾。

### China

This device contains SRRC approved Radio module CMIIT ID: 2015DJ7133

### United Kingdom



### 3.3.3 Modem

Once the modem has had an Access Point Name (APN) entered into the appropriate field, the DuraTracker is able to be connected to by the modem if it has a static IP address. The DuraTracker can be set up with a call-in window to be able to access the unit at specific times, but this decreases battery life since it is on at the same times whether the unit is being contacted or not. The DuraTracker automatically turns on a 20 minute call window each time the power is cycled (by removing all batteries for 60 seconds). The user can also send the SMS message “status” to the units phone number and it will turn on a 20 minute call window once it reads the SMS message. The DuraTracker has a setting for how often it wakes up to check for SMS messages that can be set to 15 minutes, 30 minutes, 1 hour, 2 hours, 4 hours, 12 hours, or 24 hours.

#### **Note**

Default is set to 1 hour, which results in the DuraTracker checking SMS messages at the top of every hour.

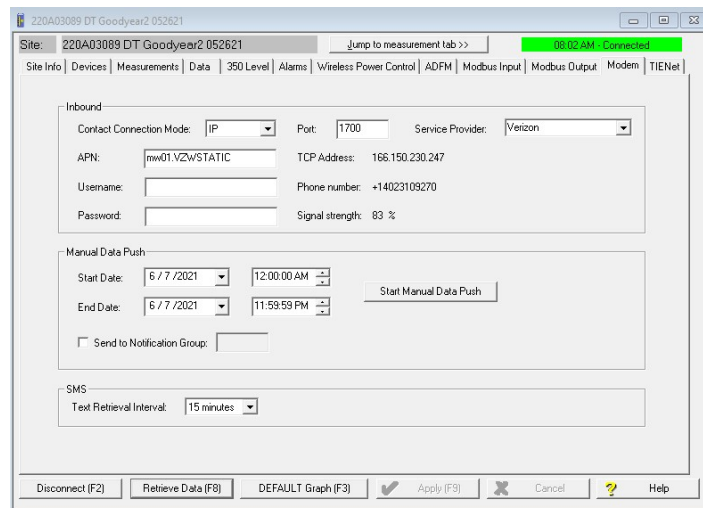

Figure 3-3 Flowlink Modem Tab

### 3.3.4 Remote Updates

Using a computer with Flowlink installed and an appropriate cellular service, you can access your remote monitoring site to remotely update the firmware. Bundled along with Flowlink is the UpdateSoftware program that can be used to achieve this. The DuraTracker must already have a call window set up, or you can send the SMS message “status” to the units phone number; then it will turn on a 20 minute call window once it reads the SMS message. Default SMS setting in Flowlink is 1 hour, so the SMS message would be checked at the top of the next hour. The return SMS message will contain the DuraTracker plus the last 3 digits of the serial number, site name, IP Address, and Status. After opening the UpdateSoftware program, enter the IP Address in the Modem section and click Connect. Once you have logged into the DuraTracker, just follow the prompts to update the firmware with the new firmware file that you previously downloaded from the Teledyne ISCO website.

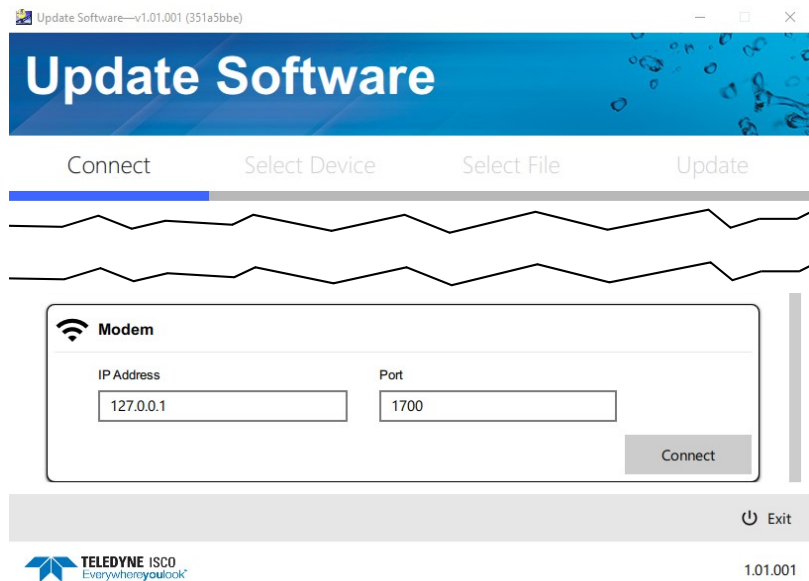

Figure 3-4 The UpdateSoftware Program.

### 3.3.5 Remote Data Retrieval

Using a computer running Flowlink and an appropriate cellular service, you can access your remote monitoring site in order to configure the flow module settings and retrieve flow data. Detailed instructions can be found in the Flowlink User Manual and Help files.

As a default Flowlink setting, the Quick Connect dialog box opens when you start Flowlink. To open Quick Connect manually, click the Quick Connect icon in the Flowlink toolbar. Then, click the DuraTracker button to connect. Flowlink will read the DuraTracker system information and attempt to match it with an existing site in the open database. If Flowlink cannot find a match for the connected site, it creates a new site within the database.

### 3.3.6 SMS

Using LTE technology and the appropriate SIM card, the DuraTracker is capable of sending digital text messages to up to five text-capable cellular devices when a pre-programmed alarm condition occurs. Consult the Flowlink User Manual and Help files for detailed information.

You can text “STATUS” to the unit’s phone number and it will open up a 20 minute call window and send you its IP address. You can then use Flowlink to connect to the device remotely.

### 3.3.7 Datapush

The DuraTracker can automatically send data to a designated server running ISCO Flowlink Pro software. The user-specified primary data transmission interval (5 minutes to 24 hours) can automatically change to a secondary interval when specific site conditions occur at the monitoring site. An Oracle® or Microsoft® SQL database is required to use this feature. Contact the factory for additional information.

To use the data push capability, connect to the DuraTracker and select the DATA tab. Click the PUSHED DATA button to set up a schedule for the data to be pushed to a Flowlink Pro server.

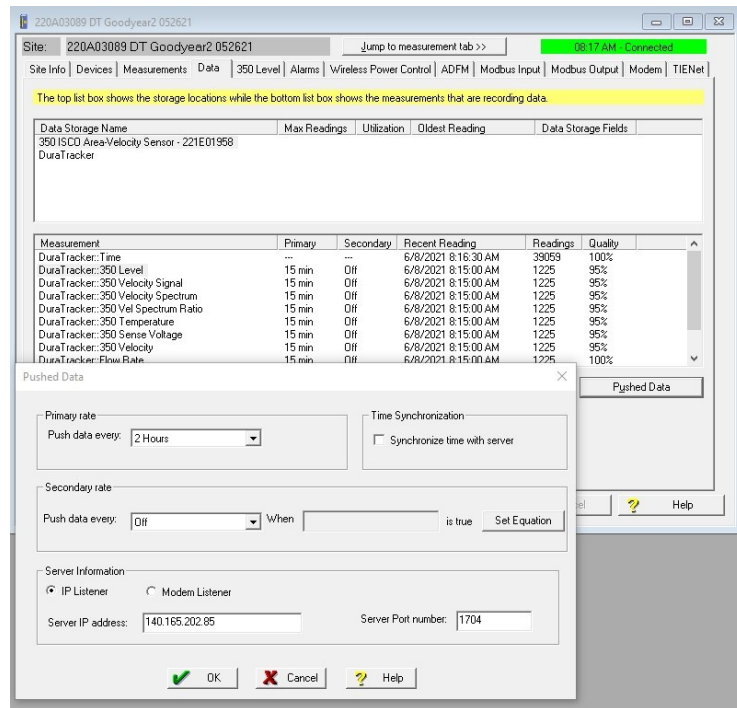

Figure 3-5 Data tab

Detailed Flowlink instructions are beyond the scope of this manual. Flowlink’s operating instructions are available in a Windows Help format. You can access the Help topics for an active window by clicking its HELP button or by pressing F1 on your computer’s keyboard. You can also access Help topics by selecting HELP from the Flowlink menu.

### 3.3.8 Check connection

The connection to the server can be checked by running a manual data push. To start the manual data push, select the MODEM tab. You can change the amount of data to push by changing the START DATE/TIME and the END DATE/TIME. By default, these values are set to the 24-hour period of the current days date. Click START MANUAL DATA PUSH, and a window will appear that shows the connection. It will list each thing that it is doing and let you know if it fails along the way.

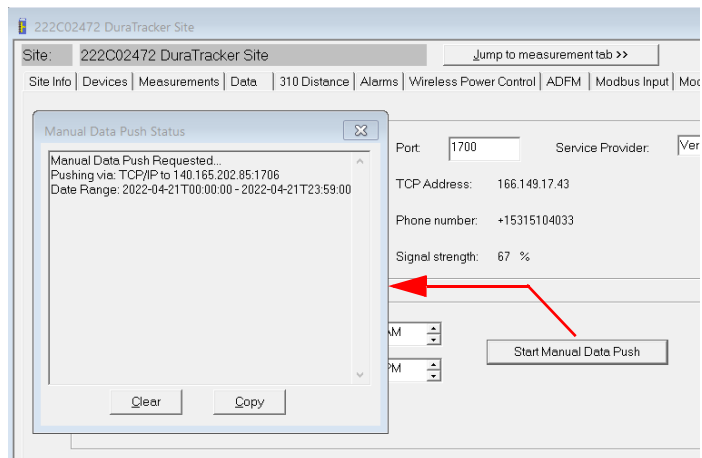
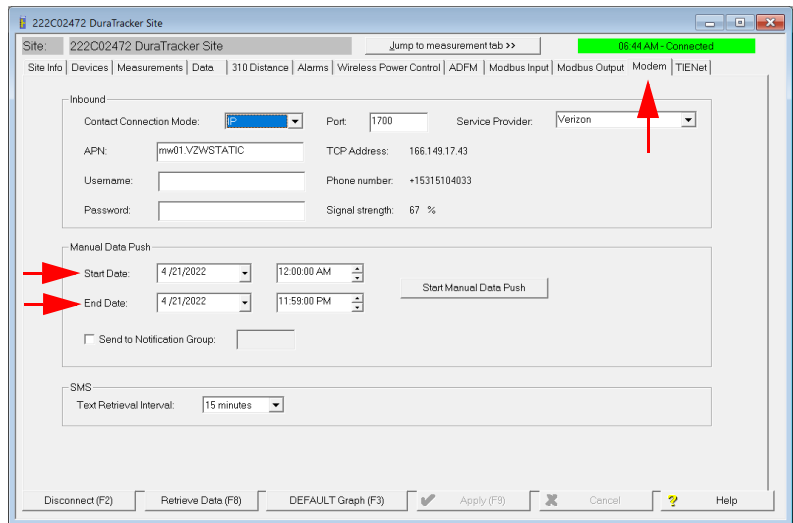

Figure 3-6 Manual Data Push

### 3.4 Configuration

#### 3.4.1 Program Settings

The Site window of Flowlink contains all of the program settings that control the site's operation. The settings are entered within eight tabs as described in Table 3-1:

Table 3-1 Site Window Tabs	
Site Info	Basic Site Information
Devices	Connected Sensors
Measurements	Sensor Measurements
Data	Data Information
Alarms	Alarm Information
Wireless Power Control	Modem and Bluetooth Times
Modbus Input	Modbus Input Information
Modbus Output	Modbus Output Information
Modem	Modem Setup
TIENet	TIENet Sensor Setup

#### 3.4.2 Site Name

The DuraTracker is shipped with default names assigned to the unit so communication can immediately begin with Flowlink. To change the default site name, access the SITE INFO tab in Flowlink. The name must be unique among other site names already present in the Flowlink database.

Site names can be up to 20 characters long. Invalid characters include:

Table 3-2 Invalid Characters	
/	Forward slash
\	Back slash
:	Colon
*	Asterisk
?	Question mark
“	Double-quote
<	Left angle bracket
>	Right angle bracket
	Bar
&	Ampersand

### 3.4.3 Devices

TIENet devices that can be used are the 301pH and Temp sensor, 306 Sampler Interface, 310 Ex Ultrasonic sensor, 350 Area Velocity sensor, 350 Ex Area Velocity sensor, 360 LaserFlow velocity sensor, and 360 LaserFlow Ex velocity sensor.

Standard DuraTracker:

- The limit of 4 TIENet devices with any combination of 350, 310, 306, or 301, excluding the 360 LaserFlow.
- The limit of 360 LaserFlow sensors is 1, with a combination of up to 3 other TIENet devices (350, 310, 306, or 301).

 <b>Note</b>
---

360 LaserFlow battery banks will run in parallel at all times. It is recommended to use both banks of batteries when running a 360 LaserFlow.

### 3.4.4 TIENet Setup

Selecting the TIENet tab will show what active TIENet devices are connected to the DuraTracker.

#### *Perform Scan*

If TIENet devices have been added or removed from the system, Click on SCAN to detect the current system configuration.

#### *Sensor Differences*

If there are any differences in the device configuration since the last scan, a list of Sensor Differences will appear.

**Missing Sensors** - The Missing Sensors list will indicate any previously connected devices that are no longer detected. Select **Retain** to keep the identification information for a previous device; select **Remove** to delete it.

**Replaced Sensors** - The Replaced Sensors list displays any newly added sensors that have replaced Missing Sensors that have been Retained.

**Available TIENet Devices** - Devices that are not currently configured show up here after a scan. Selecting a device and clicking on ADD will configure the device and moves it to the Active TIENet Devices window.

#### *Configure Active Parameters*

Highlight the sensor in Active TIENet Devices window and click on CONFIGURE ACTIVE PARAMETERS to begin setting up measurement parameters for that TIENet device.

To activate a measurement, highlight the check box next to it and press OK.



Configure TIENet Measurements

<input checked="" type="checkbox"/> 301 pH	<input checked="" type="checkbox"/> 301 Temperature
--	---

*Figure 3-7 301 pH and Temperature Sensor Parameters*

Configure TIENet Measurements

<input checked="" type="checkbox"/> 306 Sample Bottle	<input checked="" type="checkbox"/> 306 Input Voltage
---	---

*Figure 3-8 306 Sampler Interface Parameters*

Configure TIENet Measurements

<input checked="" type="checkbox"/> 310 Distance	<input checked="" type="checkbox"/> 310 Level
<input checked="" type="checkbox"/> 310 Air Temperature	<input checked="" type="checkbox"/> 310 Ultrasonic Signal

*Figure 3-9 310 Ex Ultrasonic Sensor Parameters*

Configure TIENet Measurements

<input checked="" type="checkbox"/> 350 Level	<input checked="" type="checkbox"/> 350 Temperature
<input checked="" type="checkbox"/> 350 Velocity	<input checked="" type="checkbox"/> 350 Velocity Signal
<input checked="" type="checkbox"/> 350 Velocity Spectrum	<input checked="" type="checkbox"/> 350 Vel Spectrum Ratio
<input checked="" type="checkbox"/> 350 Sense Voltage	

*Figure 3-10 350 Ex Area Velocity Sensor Parameters*

Configure TIENet Measurements

<input checked="" type="checkbox"/> 360 Distance	<input checked="" type="checkbox"/> 360 Level
<input checked="" type="checkbox"/> 360 Velocity	<input checked="" type="checkbox"/> 360 Case Temperature
<input checked="" type="checkbox"/> 360 Laser Temperature	<input checked="" type="checkbox"/> 360 X-Axis
<input checked="" type="checkbox"/> 360 Y-Axis	<input checked="" type="checkbox"/> 360 Laser Diode Current
<input checked="" type="checkbox"/> 360 Ultrasonic Signal	<input checked="" type="checkbox"/> 360 Temperature
<input checked="" type="checkbox"/> 360 Sense Voltage	<input checked="" type="checkbox"/> 360 Air Temperature
<input checked="" type="checkbox"/> 360 Doppler Power	

*Figure 3-11 360 LaserFlow Sensor Parameters*

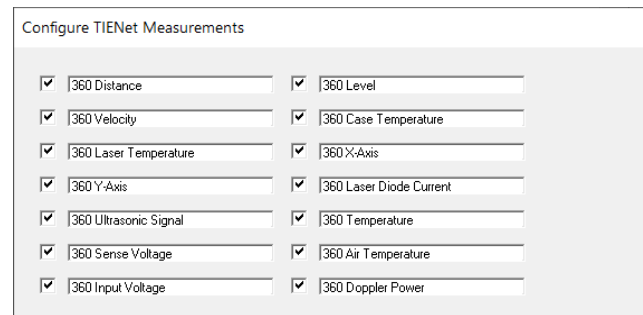

Figure 3-12 360 LaserFlow Ex Sensor Parameters

### 3.4.5 Data Storage Settings

Review the data storage settings within the DATA tab in Flowlink to ensure the pertinent types of data are being stored, and that the rate at which data is stored will provide a sufficient amount of data for your application.

The default data storage rate for the DuraTracker is set at once every 15 minutes for all readings except for total flow and input voltage readings which the default rate is once every 24 hours. You can modify the data storage rates to log readings more or less often.

**Note**

Although the DuraTracker can log data once every 15 seconds, increased data storage rates will shorten battery life, increase memory usage, and lengthen retrieve data (interrogation) times. Take this into consideration when making adjustments.

Data storage rates, as well as the types of data stored, can be modified within the Data Storage Setup Window as shown in Figure 3-13. This window can be accessed by selecting the SET UP DATA STORAGE button from the DATA or MEASUREMENT tabs.

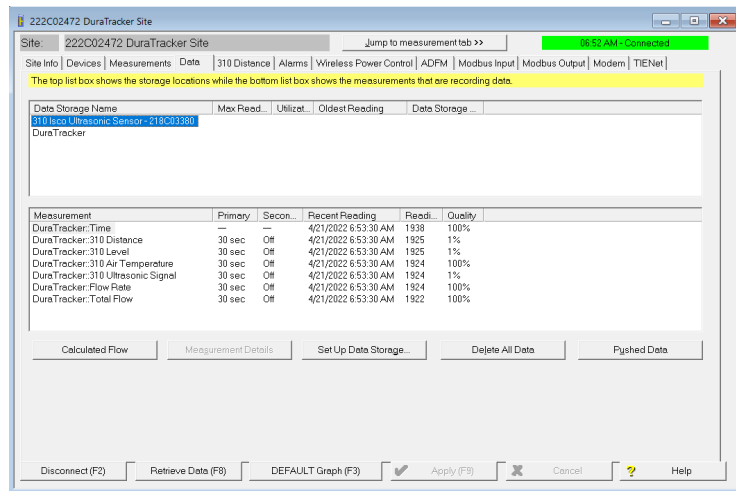

Figure 3-13 Data Storage Setup window

Each measurement has a primary and secondary storage rate. The primary storage rate specifies the rate at which data is recorded under normal conditions. The secondary storage rate specifies the rate at which data is recorded when a user-defined condition exists. For example, the secondary storage rate can be set higher than the primary storage rate in order to respond to a rising water level. Using secondary storage rates will result in better resolution of data. The primary and secondary storage rates can be set to record data from once every 15 seconds to once every 24 hours. Alternatively, the primary and secondary storage rates can be turned off, and measurement readings will still occur but will not be recorded. This may be done if that measurement is used for calculations only.

### 3.4.6 Applying Setting Changes

After modifying a setting, click APPLY or press F9 on your computer's keyboard. Flowlink sends the change to the DuraTracker and updates the site's setting in its database.

### 3.4.7 Time Resolution

The time resolution for each measurement is one second. This means that measurements are taken at the same time as the time stamp. Measurements are not collected and averaged over a period of time prior to the time stamp.

### 3.4.8 Rollover Memory

The DuraTracker utilizes rollover memory to reduce data maintenance. If memory becomes full, the DuraTracker overwrites the oldest measurement data with the newest measurement data. This occurs regardless of whether measurements are stored at the primary or secondary rate.



# DuraTracker<sup>®</sup>

---

## *Section 4 Modbus Output Protocol*

### **4.1 Overview**

Modbus is a simple command/response mechanism used to read from and write to specific digital memory locations known as registers. Modbus communication for the DuraTracker provides a standard protocol that can be used to retrieve real-time data from the DuraTrackers at a site, or multiple sites, over a wide area. The data can be sent to a central computer for display, collection, or process control. Modbus implementation is independent of Flowlink software and cannot alter the Flowlink programmed configuration of the DuraTracker. Modbus cannot be used to retrieve historical data from a DuraTracker's memory.

The DuraTracker utilizes Modbus ASCII and Modbus RTU protocols. Due to the wide variety of configurations that can be made with Modbus, it is impossible to cover every usable application within this user manual. Instead, this section outlines the basic capabilities and operations of Modbus output protocol as it applies to the DuraTracker. For this user manual, Modbus ASCII is discussed as it has more liberal communication timing requirements.

Commonly used terms related to Modbus output protocol are defined in Section 4.4.

### **4.2 Setup**

To use Modbus Output on the DuraTracker, a jumper on the circuit board must be moved. This will allow Modbus output to be used but will result in higher battery consumption. Once the following has been completed, Modbus will be available to use.

1. Remove batteries from DuraTracker and open the front electronics panel by removing the six screws on the front of the unit. Before opening the case, make sure you are grounded so that you do not damage the internal components with an Electrostatic Discharge (ESD).



Figure 4-1 Screw removal

**⚠ CAUTION**

If case is opened to install a modem, change a SIM card or setup Modbus, ESD protection must be observed. Failing to do so could result in damage to the DuraTracker.

2. Open the case and disconnect the electrical connector and reference line from battery box.



Figure 4-2 Disconnecting electrical connector and reference line

3. Move Jumper J3 Modbus Power from the OFF position to the ON position.

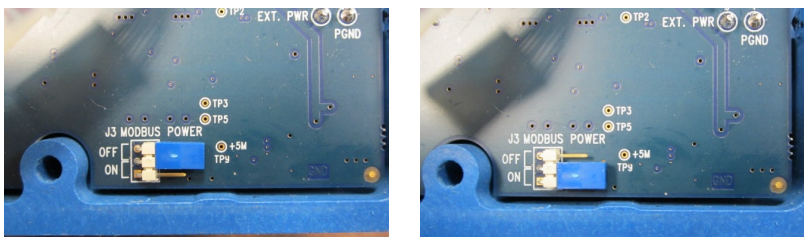

Figure 4-3 Jumper position

4. Reconnect the electrical connector and reference line.

5. Line up the two halves of the case, being careful to make sure the wires from the electrical connector do not get pinched between the two halves.
6. Reattach the front panel with the O-ring screws removed in step 1. When starting screws in plastic, you should always start turning them counterclockwise until you feel/hear the audible click of the threads lining up. Once the threads line up you can turn the screw clockwise to tighten it down. This will ensure you do not cross-thread the plastic holes.

 **Note**

Do not install screws using power tools. Use only hand tools.

## 4.3 Operation

### 4.3.1 Establishing Communication

Several communications protocols supported in the DuraTracker series that require auto-baud rate detection. As a result, each time a Modbus connection is made, the module uses a polling mechanism to repeatedly send a command until a response is received. It may take up to 20 command retries before the unit has identified the baud rate and a response is received.

### 4.3.2 Module Addressing

When connecting to a site via a Modbus OPC server, use a dedicated line of communication to the DuraTracker from the OPC server. This can be a dedicated communications cable (direct connection) or a dedicated phone number (modem).

While using a direction connection, you are dedicating a specified COM port on the computer. That COM port determines the site to which you are connecting.

While using a modem, the dedicated line is defined by the site's phone number. If you connect more than one DuraTracker at a site, the Modbus OPC server must have some way of differentiating between the units. When sending a command to a specific unit, the command has an address field. This allows the server software to communicate with and control the specified unit while ignoring other units at that site.

### 4.3.3 Configurations

A variety of configurations can be created with Modbus through direct connection or through a modem.

Figure 4-4 shows a direct connection between a server PC and a DuraTracker site using the COM ports on the OPC server. These COM ports are directly connected to the remote sites. Connection to the unit is made through the Power/Modbus communication port on the front of the DuraTracker.

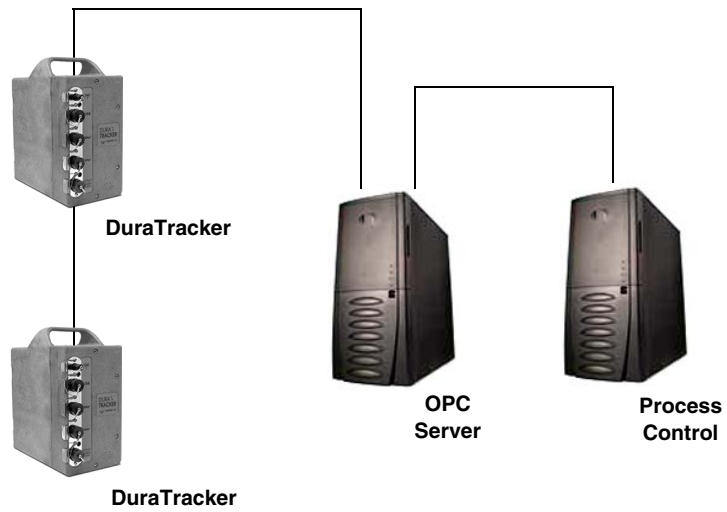

Figure 4-4 Configuration example

The operation sequence of the configuration shown in Figure 4-4 is as follows:

1. The DuraTrackers take readings from the probes.
2. The DuraTrackers store readings (level, velocity, flow rate, etc.) in their specified registers.
3. The user requests data through Process Control.
4. Process Control requests information from the OPC server.
5. The OPC server connects to the DuraTracker through the Power/Modbus port (direct connection), copies register data from the specified DuraTracker, and populates its holding index with this data.
6. Process Control retrieves the data from the OPC server's holding index and supplies the data to the user.

**Note**

Process Control can be activated manually or automatically in this example. The OPC server and Process Control may be physically located on the same computer.

## 4.4 Glossary of Terms

Table 4-1 defines terms commonly used with Modbus output protocol:



**Table 4-1 Modbus Terms**

ASCII	American Standard Code for Information Interchange (ASCII) is a code that represents English characters with numbers. Most computers represent characters with ASCII code. This makes it possible for one computer or device to share data with another. DuraTracker supports Modbus ASCII.
DCS	Distributed Control Systems.
Dedicated Line	A dedicated line is a telecommunication path reserved for communication between two specified points and not shared among multiple points.
Modbus Protocol	A Modbus protocol is a messaging structure used to establish master/slave server communications between intelligent devices. Modbus is a simple command/response mechanism to read from and write to registers.
MTU	Master Terminal Unit.
OPC	Object linking and embedding for Process Control (OPC) is a type of open connectivity which uses free-for-use standards. It is a series of software standards specifications that act as a translator for data transmission and process control. The specification defines a standard set of objects, interfaces, and methods for use in process control and manufacturing automation appliances to facilitate interoperability.
PLC	Programmable Logic Controller.
Register	A register is a location in digital memory that have specific data stored for retrieval or for use with control functions. The definition of what information is contained and where (i.e., the registry number or address) is decided by the manufacturer, Teledyne ISCO.
RTU	Remote Terminal Unit.

**Table 4-1 Modbus Terms**

SCADA	A Supervisory Control And Data Acquisition (SCADA) is a computer system for gathering and analyzing real-time data. SCADA systems are used to monitor and control plant operation or equipment used in industries such as telecommunications, water and wastewater control, energy, oil and gas refining, and transportation. The SCADA system transfers information to a central site, alerting the site of conditions, and performing necessary analysis and control. This information is displayed in a logical and organized manner.
TCP/IP	Transmission Control Protocol/Internet Protocol.

#### 4.5 DuraTracker ASCII or RTU Address

The DuraTracker's address (Device ID) is user programmable between 2 and 247.

 <b>CAUTION</b>
---

Be careful not to assign the same address to more than one Logger.

#### 4.6 Register Definitions

The register definitions for the DuraTracker Logger are provided in the following table.

Where no other Unit Of Measure exists for a parameter, percent (%) can be used in most situations.

##### 4.6.1 Modbus Registers

Modbus tables are available through Flowlink.

**Table C-1 Output Registers for DuraTracker Flowmeter**

Register Number	Name	Data Type	Units of Measure	Read/Write	Description
40025	TakeReadingFlag	Word		R/W	Set to 1 to update readings, 2 for automatic update
40026	UpdateInterval	Word	Seconds	R/W	The reading update interval in seconds
40027	Activeflags	Word		R	The bit fields to indicate which sensors are active
40040 40041	Level	Float	Meters	R	Level
40042	Levelstatus	Word		R	Non-zero is an error
40043 - 48	Leveltime	Word		R	The last level reading time, sec-min-hour-day-month-year
40055 40056	Level1	Float	Meters	R	Level 1
40057	Level1status	Word		R	Non-zero is an error
40058 - 63	Level1time	Word		R	The last level 1 reading time, sec-min-hour-day-month-year
40070 40071	Level2	Float	Meters	R	Level 2
40072	Level2status	Word		R	Non-zero is an error
40073 - 78	Level2time	Word		R	The last level 2 reading time, sec-min-hour-day-month-year
40085 40086	Level3	Float	Meters	R	Level 3
40087	Level3status	Word		R	Non-zero is an error
40088 - 93	Level3time	Word		R	The last level 3 reading time, sec-min-hour-day-month-year
40100 40101	Level4	Float	Meters	R	Level 4
40102	Level4status	Word		R	Non-zero is an error
40103 - 08	Level4time	Word		R	The last level 4 reading time, sec-min-hour-day-month-year
40115 40116	Level5	Float	Meters	R	Level 5
40117	Level5status	Word		R	Non-zero is an error
40118 - 23	Level5time	Word		R	The last level 5 reading time, sec-min-hour-day-month-year
40130 40131	Level6	Float	Meters	R	Level 6
40132	Level6status	Word		R	Non-zero is an error

40133 - 38	Level6time	Word		R	The last level 6 reading time, sec-min-hour-day-month-year
40145 40146	Level7	Float	Meters	R	Level 7
40157	Level7status	Word		R	Non-zero is an error
40158 - 63	Level7time	Word		R	The last level 7 reading time, sec-min-hour-day-month-year
40160 40161	Velocity	Float	Meters/Sec	R	Velocity
40162	Velocitystatus	Word		R	Non-zero is an error
40163 - 68	Velocitytime	Word		R	The last velocity reading time, sec-min-hour-day-month-year
40175 40176	Velocity1	Float	Meters/Sec	R	Velocity 1
40177	Velocity1status	Word		R	Non-zero is an error
40178 - 83	Velocity1time	Word		R	The last velocity 1 reading time, sec-min-hour-day-month-year
40190 40191	Velocity2	Float	Meters/Sec	R	Velocity 2
40192	Velocity2status	Word		R	Non-zero is an error
40193 - 98	Velocity2time	Word		R	The last velocity 2 reading time, sec-min-hour-day-month-year
40205 40206	Velocity3	Float	Meters/Sec	R	Velocity 3
40207	Velocity3status	Word		R	Non-zero is an error
40208 - 13	Velocity3time	Word		R	The last velocity 3 reading time, sec-min-hour-day-month-year
40220 40221	Velocity4	Float	Meters/Sec	R	Velocity 4
40222	Velocity4status	Word		R	Non-zero is an error
40223 - 28	Velocity4time	Word		R	The last velocity 4 reading time, sec-min-hour-day-month-year
40235 40236	Velocity5	Float	Meters/Sec	R	Velocity 5
40237	Velocity5status	Word		R	Non-zero is an error
40238 - 43	Velocity5time	Word		R	The last velocity 5 reading time, sec-min-hour-day-month-year
40250 40251	Velocity6	Float	Meters/Sec	R	Velocity 6
40252	Velocity6status	Word		R	Non-zero is an error
40253 - 58	Velocity6time	Word		R	The last velocity 6 reading time, sec-min-hour-day-month-year
40265 40266	Velocity7	Float	Meters/Sec	R	Velocity 7

40267	Velocity7status	Word		R	Non-zero is an error
40268 - 73	Velocity7time	Word		R	The last velocity 7 reading time, sec-min-hour-day-month-year
40280 40281	Flowrate	Float	Cubic Meters/Sec	R	Flow rate
40282	Flowratestatus	Word		R	Non-zero is an error
40283 - 88	Flowratetime	Word		R	The last flow rate reading time, sec-min-hour-day-month-year
40295 40296	Flowrate1	Float	Cubic Meters/Sec	R	Flow rate 1
40297	Flowrate1status	Word		R	Non-zero is an error
40298 - 303	Flowrate1time	Word		R	The last flow rate 1 reading time, sec-min-hour-day-month-year
40310 40311	Flowrate2	Float	Cubic Meters/Sec	R	Flow rate 2
40312	Flowrate2status	Word		R	Non-zero is an error
40313 - 18	Flowrate2time	Word		R	The last flow rate 2 reading time, sec-min-hour-day-month-year
40325 40326	Flowrate3	Float	Cubic Meters/Sec	R	Flow rate 3
40327	Flowrate3status	Word		R	Non-zero is an error
40328 - 33	Flowrate3time	Word		R	The last flow rate 3 reading time, sec-min-hour-day-month-year
40340 40341	Flowrate4	Float	Cubic Meters/Sec	R	Flow rate 4
40342	Flowrate4status	Word		R	Non-zero is an error
40343 - 48	Flowrate4time	Word		R	The last flow rate 4 reading time, sec-min-hour-day-month-year
40355 40356	Flowrate5	Float	Cubic Meters/Sec	R	Flow rate 5
40357	Flowrate5status	Word		R	Non-zero is an error
40358 - 63	Flowrate5time	Word		R	The last flow rate 5 reading time, sec-min-hour-day-month-year
40370 40371	Flowrate6	Float	Cubic Meters/Sec	R	Flow rate 6
40372	Flowrate6status	Word		R	Non-zero is an error
40373 - 78	Flowrate6time	Word		R	The last flow rate 6 reading time, sec-min-hour-day-month-year
40385 40386	Flowrate7	Float	Cubic Meters/Sec	R	Flow rate 7
40387	Flowrate7status	Word		R	Non-zero is an error
40388 - 93	Flowrate7time	Word		R	The last flow rate 7 reading time, sec-min-hour-day-month-year

40400 40401	Temperature	Float	Degrees Celsius	R	Temperature
40402	Temperaturestatus	Word		R	Non-zero is an error
40403 - 08	Temperaturetime	Word		R	The last temperature reading time, sec-min-hour-day-month-year
40415 40416	Temperature1	Float	Degrees Celsius	R	Temperature 1
40417	Temperature1status	Word		R	Non-zero is an error
40418 - 23	Temperature1time	Word		R	The last temperature 1 reading time, sec-min-hour-day-month-year
40430 40431	Temperature2	Float	Degrees Celsius	R	Temperature 2
40432	Temperature2status	Word		R	Non-zero is an error
40433 - 38	Temperature2time	Word		R	The last temperature 2 reading time, sec-min-hour-day-month-year
40445 40446	Temperature3	Float	Degrees Celsius	R	Temperature 3
40447	Temperature3status	Word		R	Non-zero is an error
40448 - 53	Temperature3time	Word		R	The last temperature 3 reading time, sec-min-hour-day-month-year
40460 40461	Volume	Float	Cubic Meters	R	Volume
40462	Volumestatus	Word		R	Non-zero is an error
40463 - 68	Volumetime	Word		R	The last volume reading time, sec-min-hour-day-month-year
40475 40476	Volume1	Float	Cubic Meters	R	Volume 1
40477	Volume1status	Word		R	Non-zero is an error
40478 - 83	Volume1time	Word		R	The last volume 1 reading time, sec-min-hour-day-month-year
40490 40491	Volume2	Float	Cubic Meters	R	Volume 2
40492	Volume2status	Word		R	Non-zero is an error
40493 - 98	Volume2time	Word		R	The last volume 2 reading time, sec-min-hour-day-month-year
40505 40506	Volume3	Float	Cubic Meters	R	Volume 3
40507	Volume3status	Word		R	Non-zero is an error
40508 - 13	Volume3time	Word		R	The last volume 3 reading time, sec-min-hour-day-month-year

40520 40521	Voltage	Float	Volts	R	Voltage
40522	Voltagestatus	Word		R	Non-zero is an error
40523 - 28	Voltage1time	Word		R	The last voltage reading time, sec-min-hour-day-month-year
40535 40536	Voltage1	Float	Volts	R	Voltage 1
40537	Voltage1status	Word		R	Non-zero is an error
40538 - 43	Voltage1time	Word		R	The last voltage 1 reading time, sec-min-hour-day-month-year
40550 40551	Voltage2	Float	Volts	R	Voltage 2
40552	Voltage2status	Word		R	Non-zero is an error
40553 - 58	Voltage2time	Word		R	The last voltage 2 reading time, sec-min-hour-day-month-year
40565 40566	Voltage3	Float	Volts	R	Voltage 3
40567	Voltage3status	Word		R	Non-zero is an error
40568 - 73	Voltage3time	Word		R	The last voltage 3 reading time, sec-min-hour-day-month-year
40580 40581	Analog/%	Float	4-20mA/ 0-100%	R	Analog output or percentage
40582	Analog/status	Word		R	Non-zero is an error
40583 - 88	Analog/time	Word		R	The last Analog output or percentage reading time, sec-min-hour-day-month-year
40595 40596	Analog/1	Float	4-20mA/ 0-100%	R	Analog output 1 or percentage
40597	Analog/1status	Word		R	Non-zero is an error
40598 - 608	Analog/1time	Word		R	The last Analog output 1 or percentage reading time, sec-min-hour-day-month-year
40610 40611	Analog/2	Float	4-20mA/ 0-100%	R	Analog output 2 or percentage
40612	Analog/2status	Word		R	Non-zero is an error
40613 - 18	Analog/2time	Word		R	The last Analog output 2 or percentage reading time, sec-min-hour-day-month-year
40625 40626	Analog/3	Float	4-20mA/ 0-100%	R	Analog output 3 or percentage
40627	Analog/3status	Word		R	Non-zero is an error
40628 - 33	Analog/3time	Word		R	The last Analog output 3 or percentage reading time, sec-min-hour-day-month-year

40640 40641	Analog/4	Float	4-20mA/ 0-100%	R	Analog output 4 or percentage
40642	Analog/4status	Word		R	Non-zero is an error
40643 -48	Analog/4time	Word		R	The last Analog output 4 or percentage reading time, sec-min-hour-day-month-year
40655 40656	Analog/5	Float	4-20mA/ 0-100%	R	Analog output 5 or percentage
40657	Analog/5status	Word		R	Non-zero is an error
40658 -63	Analog/5time	Word		R	The last Analog output 5 or percentage reading time, sec-min-hour-day-month-year
40670 40671	Analog/6	Float	4-20mA/ 0-100%	R	Analog output 6 or percentage
40672	Analog/6status	Word		R	Non-zero is an error
40673 -78	Analog/6time	Word		R	The last Analog output 6 or percentage reading time, sec-min-hour-day-month-year
40685 40686	Analog/7	Float	4-20mA/ 0-100%	R	Analog output 7 or percentage
40687	Analog/7status	Word		R	Non-zero is an error
40688 -93	Analog/7time	Word		R	The last Analog output 7 or percentage reading time, sec-min-hour-day-month-year
40700 40701	Analog/8	Float	4-20mA/ 0-100%	R	Analog output 8 or percentage
40702	Analog/8status	Word		R	Non-zero is an error
40703 -08	Analog/8time	Word		R	The last Analog output 8 or percentage reading time, sec-min-hour-day-month-year
40715 40716	Analog/9	Float	4-20mA/ 0-100%	R	Analog output 9 or percentage
40717	Analog/9status	Word		R	Non-zero is an error
40718 -23	Analog/9time	Word		R	The last Analog output 9 or percentage reading time, sec-min-hour-day-month-year
40730 40731	Analog/10	Float	4-20mA/ 0-100%	R	Analog output 10 or percentage
40732	Analog/10status	Word		R	Non-zero is an error
40733 -38	Analog/10time	Word		R	The last Analog output 10 or percentage reading time, sec-min-hour-day-month-year
40745 40746	Analog/11	Float	4-20mA/ 0-100%	R	Analog output 11 or percentage



40747	Analog/11status	Word		R	Non-zero is an error
40748 -53	Analog/11time	Word		R	The last Analog output 11 or percentage reading time, sec-min-hour-day-month-year
40760 40761	Analog/12	Float	4-20mA/ 0-100%	R	Analog output 12 or percentage
40762	Analog/12status	Word		R	Non-zero is an error
40763 -68	Analog/12time	Word		R	The last Analog output 12 or percentage reading time, sec-min-hour-day-month-year
40775 40776	Analog/13	Float	4-20mA/ 0-100%	R	Analog output 13 or percentage
40777	Analog/13status	Word		R	Non-zero is an error
40778 -83	Analog/13time	Word		R	The last Analog output 13 or percentage reading time, sec-min-hour-day-month-year
40790 40791	Analog/14	Float	4-20mA/ 0-100%	R	Analog output 14 or percentage
40792	Analog/14status	Word		R	Non-zero is an error
40793 -98	Analog/14time	Word		R	The last Analog output 14 or percentage reading time, sec-min-hour-day-month-year
40805 40806	Analog/15	Float	4-20mA/ 0-100%	R	Analog output 15 or percentage
40807	Analog/15status	Word		R	Non-zero is an error
40808 -13	Analog/15time	Word		R	The last Analog output 15 or percentage reading time, sec-min-hour-day-month-year
40880 40881	Fluorescence	Float	%	R	
40882	Fluorescencestatus	Word		R	
40883 - 88	Fluorescencetime	Word		R	
40895 40896	Fluorescence1	Float	%	R	
40897	Fluorescence1status	Word		R	
40898 - 903	Fluorescence1time	Word		R	
40910 40911	Fluorescence2	Float	%	R	
40912	Fluorescence2status	Word		R	
40913 - 18	Fluorescence2time	Word		R	
40925 40926	Fluorescence3	Float	%	R	
40927	Fluorescence3status	Word		R	
40928 - 33	Fluorescence3time	Word		R	

40940 40941	Battery	Float	Volts	R	
40942	Batterystatus	Word		R	
40943 - 48	Batterytime	Word		R	
40955 40956	Battery1	Float	Volts	R	
40957	Battery1status	Word		R	
40958 - 63	Battery1time	Word		R	
40970 40971	Battery2	Float	Volts	R	
40972	Battery2status	Word		R	
40973 - 78	Battery2time	Word		R	
40985 40986	Battery3	Float	Volts	R	
40987	Battery3status	Word		R	
40988 - 93	Battery3time	Word		R	
41000 41001	Dissolved Gas	Float	mmHg	R	
41002	Dissolved Gasstatus	Word		R	
41003 - 08	Dissolved Gastime	Word		R	
41015 41016	Dissolved Gas1	Float	mmHg	R	
41017	Dissolved Gas1status	Word		R	
41018 - 23	Dissolved Gas1time	Word		R	
41030 41031	Dissolved Gas2	Float	mmHg	R	
41032	Dissolved Gas2status	Word		R	
41033 - 38	Dissolved Gas2time	Word		R	
41045 41046	Dissolved Gas3	Float	mmHg	R	
41047	Dissolved Gas3status	Word		R	
41048 - 53	Dissolved Gas3time	Word		R	
41120 41121	Photosyn Rad	Float	umol s1 m2	R	
41122	Photosyn Radstatus	Word		R	
41123 - 28	Photosyn Radtime	Word		R	
41135 41136	Photosyn Rad1	Float	umol s1 m2	R	
41137	Photosyn Rad1status	Word		R	
41138 - 43	Photosyn Rad1time	Word		R	
41150 41151	Photosyn Rad2	Float	umol s1 m2	R	
41152	Photosyn Rad2status	Word		R	
41153 - 58	Photosyn Rad2time	Word		R	

41165 41166	Photosyn Rad3	Float	umol s1 m2	R	
41167	Photosyn Rad3status	Word		R	
41168 - 73	Photosyn Rad3time	Word		R	
41180 41181	Transmissivity	Float	%	R	
41182	Transmissivitystatus	Word		R	
41183 - 88	Transmissivitytime	Word		R	
41195 41196	Transmissivity1	Float	%	R	
41197	Transmissivity1status	Word		R	
41198 - 203	Transmissivity1time	Word		R	
41210 41211	Transmissivity2	Float	%	R	
41212	Transmissivity2status	Word		R	
41213 - 18	Transmissivity2time	Word		R	
41225 41226	Transmissivity3	Float	%	R	
41227	Transmissivity3status	Word		R	
41228 - 33	Transmissivity3time	Word		R	
41240 41241	Conductivity	Float	uS/cm	R	
41242	Conductivitystatus	Word		R	
41243 - 48	Conductivitytime	Word		R	
41255 41256	Conductivity1	Float	uS/cm	R	
41257	Conductivity1status	Word		R	
41258 - 63	Conductivity1time	Word		R	
41270 41271	Conductivity2	Float	uS/cm	R	
41272	Conductivity2status	Word		R	
41273 - 78	Conductivity2time	Word		R	
41285 41286	Conductivity3	Float	uS/cm	R	
41287	Conductivity3status	Word		R	
41288 - 93	Conductivity3time	Word		R	
41300 41301	Specific Conductance	Float	uS/cm	R	
41302	Specific Conductancestatus	Word		R	
41303 - 08	Specific Conductancetime	Word		R	
41315 41316	Specific Conductance1	Float	uS/cm	R	

41317	Specific Conductance1status	Word		R	
41318 - 23	Specific Conductance1time	Word		R	
41330 41331	Specific Conductance2	Float	uS/cm	R	
41332	Specific Conductance2status	Word		R	
41333 - 38	Specific Conductance2time	Word		R	
41345 41346	Specific Conductance3	Float	uS/cm	R	
41347	Specific Conductance3status	Word		R	
41348 - 53	Specific Conductance3time	Word		R	
41360 41361	Dissolved Solid	Float	mg/l	R	
41362	Dissolved Solidstatus	Word		R	
41363 - 68	Dissolved Solidtime	Word		R	
41375 41376	Dissolved Solid1	Float	mg/l	R	
41377	Dissolved Solid1status	Word		R	
41378 - 83	Dissolved Solid1time	Word		R	
41390 41391	Dissolved Solid2	Float	mg/l	R	
41392	Dissolved Solid2status	Word		R	
41393 - 98	Dissolved Solid2time	Word		R	
41405 41406	Dissolved Solid3	Float	mg/l	R	
41407	Dissolved Solid3status	Word		R	
41408 - 13	Dissolved Solid3time	Word		R	
41420 41421	Salinity	Float	mg/l	R	
41422	Salinitystatus	Word		R	
41423 - 28	Salinitytime	Word		R	
41435 41436	Salinity1	Float	mg/l	R	
41437	Salinity1status	Word		R	
41438 - 43	Salinity1time	Word		R	
41450 41451	Salinity2	Float	mg/l	R	
41452	Salinity2status	Word		R	
41453 - 58	Salinity2time	Word		R	

41465 41466	Salinity3	Float	mg/l	R	
41467	Salinity3status	Word		R	
41468 - 73	Salinity3time	Word		R	
41480 41481	Dissolved Oxygen	Float	mg/l	R	
41482	Dissolved Oxygenstatus	Word		R	
41483 - 88	Dissolved Oxygentime	Word		R	
41495 41496	Dissolved Oxygen1	Float	mg/l	R	
41497	Dissolved Oxygen1status	Word		R	
41498 - 503	Dissolved Oxygen1time	Word		R	
41510 41511	Dissolved Oxygen2	Float	mg/l	R	
41512	Dissolved Oxygen2status	Word		R	
41513 - 18	Dissolved Oxygen2time	Word		R	
41525 41526	Dissolved Oxygen3	Float	mg/l	R	
41527	Dissolved Oxygen3status	Word		R	
41528 - 33	Dissolved Oxygen3time	Word		R	
41540 41541	pH	Float	pH	R	
41542	pHstatus	Word		R	
41543 - 48	pHtime	Word		R	
41555 41556	pH1	Float	pH	R	
41557	pH1status	Word		R	
41558 - 63	pH1time	Word		R	
41570 41571	pH2	Float	pH	R	
41572	pH2status	Word		R	
41573 - 78	pH2time	Word		R	
41585 41586	pH3	Float	pH	R	
41587	pH3status	Word		R	
41588 - 93	pH3time	Word		R	

41600 41601	ORP	Float	Volts	R	
41602	ORPstatus	Word		R	
41603 - 08	ORPtime	Word		R	
41615 41616	ORP1	Float	Volts	R	
41617	ORP1status	Word		R	
41618 - 23	ORP1time	Word		R	
41630 41631	ORP2	Float	Volts	R	
41632	ORP2status	Word		R	
41633 - 38	ORP2time	Word		R	
41645 41646	ORP3	Float	Volts	R	
41647	ORP3status	Word		R	
41648 - 53	ORP3time	Word		R	
41660 41661	NH4 Nitrogen	Float	mg/l	R	
41662	NH4 Nitrogenstatus	Word		R	
41663 - 68	NH4 Nitrogentime	Word		R	
41675 41676	NH4 Nitrogen1	Float	mg/l	R	
41677	NH4 Nitrogen1status	Word		R	
41678 - 83	NH4 Nitrogen1time	Word		R	
41690 41691	NH4 Nitrogen2	Float	mg/l	R	
41692	NH4 Nitrogen2status	Word		R	
41693 - 98	NH4 Nitrogen2time	Word		R	
41705 41706	NH4 Nitrogen3	Float	mg/l	R	
41707	NH4 Nitrogen3status	Word		R	
41708 - 13	NH4 Nitrogen3time	Word		R	
41720 41721	NO3 Nitrogen	Float	mg/l	R	
41722	NO3 Nitrogenstatus	Word		R	
41723 - 28	NO3 Nitrogentime	Word		R	
41735 41736	NO3 Nitrogen1	Float	mg/l	R	
41737	NO3 Nitrogen1status	Word		R	
41738 - 43	NO3 Nitrogen1time	Word		R	
41750 41751	NO3 Nitrogen2	Float	mg/l	R	
41752	NO3 Nitrogen2status	Word		R	
41753 - 58	NO3 Nitrogen2time	Word		R	

41765 41766	NO3 Nitrogen3	Float	mg/l	R	
41767	NO3 Nitrogen3status	Word		R	
41768 - 73	NO3 Nitrogen3time	Word		R	
41780 41781	Turbidity	Float	NTU	R	
41782	Turbiditystatus	Word		R	
41783 - 88	Turbiditytime	Word		R	
41795 41796	Turbidity1	Float	NTU	R	
41797	Turbidity1status	Word		R	
41798 - 803	Turbidity1time	Word		R	
41810 41811	Turbidity2	Float	NTU	R	
41812	Turbidity2status	Word		R	
41813 - 18	Turbidity2time	Word		R	
41825 41826	Turbidity3	Float	NTU	R	
41827	Turbidity3status	Word		R	
41828 - 33	Turbidity3time	Word		R	
41840 41841	Chloride	Float	mg/l	R	
41842	Chloridestatus	Word		R	
41843 - 48	Chloridetime	Word		R	
41855 41856	Chloride1	Float	mg/l	R	
41857	Chloride1status	Word		R	
41858 - 63	Chloride1time	Word		R	
41870 41871	Chloride2	Float	mg/l	R	
41872	Chloride2status	Word		R	
41873 - 78	Chloride2time	Word		R	
41885 41886	Chloride3	Float	mg/l	R	
41887	Chloride3status	Word		R	
41888 - 93	Chloride3time	Word		R	
41900 41901	Resistivity	Float	Ohm-cm	R	
41902	Resistivitystatus	Word		R	
41903 - 08	Resistivitytime	Word		R	
41915 41916	Resistivity1	Float	Ohm-cm	R	
41917	Resistivity1status	Word		R	
41918 - 23	Resistivity1time	Word		R	

41930 41931	Resistivity2	Float	Ohm-cm	R	
41932	Resistivity2status	Word		R	
41933 - 38	Resistivity2time	Word		R	
41945 41946	Resistivity3	Float	Ohm-cm	R	
41947	Resistivity3status	Word		R	
41948 - 53	Resistivity3time	Word		R	
41960 41961	Pressure	Float	mmHg	R	
41962	Pressurestatus	Word		R	
41963 - 68	Pressuretime	Word		R	
41975 41976	Pressure1	Float	mmHg	R	
41977	Pressure1status	Word		R	
41978 - 83	Pressure1time	Word		R	
41990 41991	Pressure2	Float	mmHg	R	
41992	Pressure2status	Word		R	
41993 - 98	Pressure2time	Word		R	
42005 42006	Pressure3	Float	mmHg	R	
42007		Word		R	
42008 - 13	Pressure3time	Word		R	
42020 42021	Reserved	Float		R	
42022	Reservedstatus	Word		R	
42023 - 28	Reservedtime	Word		R	
42035 42036	Generic	Float		R	
42037	Genericstatus	Word		R	
42038 - 43	Generictime	Word		R	
42050 42051	Generic1	Float		R	
42052	Generic1status	Word		R	
42053 - 58	Generic1time	Word		R	
42065 42066	Generic2	Float		R	
42067	Generic2status	Word		R	
42068 - 73	Generic2time	Word		R	
42080 42081	Generic3	Float		R	
42082	Generic3status	Word		R	
42083 - 88	Generic3time	Word		R	



42095 42096	Generic4	Float		R	
42097	Generic4status	Word		R	
42098 - 103	Generic4time	Word		R	
42110 42111	Generic5	Float		R	
42112	Generic5status	Word		R	
42113 - 18	Generic5time	Word		R	
42125 42126	Generic6	Float		R	
42127	Generic6status	Word		R	
42128 - 33	Generic6time	Word		R	
42140 42141	Generic7	Float		R	
42142	Generic7status	Word		R	
42143 - 48	Generic7time	Word		R	
42155 42156	Generic8	Float		R	
42157	Generic8status	Word		R	
42158 - 63	Generic8time	Word		R	
42170 42171	Wireless Power	Float		R	
42172	Wireless Powerstatus	Word		R	
42172 - 78	Wireless Powertime	Word		R	
42185 42186	Wireless Power1	Float		R	
42187	Wireless Power1status	Word		R	
42188 - 93	Wireless Power1time	Word		R	
42200 42201	Wireless Power2	Float		R	
42202	Wireless Power2status	Word		R	
42203 - 08	Wireless Power2time	Word		R	
42215 42216	Wireless Power3	Float		R	
42217	Wireless Power3status	Word		R	
42218 - 23	Wireless Power3time	Word		R	
42230 42231	Wireless Power4	Float		R	
42232	Wireless Power4status	Word		R	
42233 - 38	Wireless Power4time	Word		R	

42245 42246	Wireless Power5	Float		R	
42247	Wireless Power5status	Word		R	
42248 - 53	Wireless Power5time	Word		R	
42260 42261	Wireless Power6	Float		R	
42262	Wireless Power6status	Word		R	
42263 - 68	Wireless Power6time	Word		R	
42275 42276	Wireless Power7	Float		R	
42277	Wireless Power7status	Word		R	
42278 - 83	Wireless Power7time	Word		R	
42290 42291	Humidity	Float		R	
42292	Humiditystatus	Word		R	
42293 - 98	Humiditytime	Word		R	
42305 42306	Humidity1	Float		R	
42307	Humidity1status	Word		R	
42308 - 13	Humidity1time	Word		R	
42320 42321	Humidity2	Float		R	
42322	Humidity2status	Word		R	
42323 - 28	Humidity2time	Word		R	
42335 42336	Humidity3	Float		R	
42337	Humidity3status	Word		R	
42338 - 43	Humidity3time	Word		R	
42350 42351	Angle	Float		R	
42352	Anglestatus	Word		R	
42353 - 58	Angletime	Word		R	
42365 42366	Angle1	Float		R	
42367	Angle1status	Word		R	
42368 - 73	Angle1time	Word		R	
42380 42381	Angle2	Float		R	
42382	Angle2status	Word		R	
42383 - 88	Angle2time	Word		R	

42395 42396	Angle3	Float		R	
42397	Angle3status	Word		R	
42398 - 403	Angle3time	Word		R	



# DuraTracker®

---

## Section 5 Maintenance

### 5.1 Overview

This section describes the maintenance requirements of the DuraTracker. The DuraTracker flow meter is designed to perform reliably in adverse conditions with a minimal amount of routine service. To keep your system working properly, the battery power and desiccant condition should be checked at regular intervals.

Maintenance intervals are affected by many variables. For example, the number of sensors and the data storage rate will affect the battery life. Additionally, humidity levels affect the service life of the desiccant. Generally, a basic system installed in an environment with moderate humidity levels should function well with maintenance intervals under three months.

A weekly maintenance interval is recommended until an understanding of the DuraTracker's operational capabilities under differing environmental conditions is gained.

 <b>CAUTION</b>
--

If the case is opened to install a modem, change a SIM card, or set up Modbus, ESD protection must be observed. Failing to do so could result in damage to the DuraTracker.

### 5.2 Maintenance Kits

The maintenance kit for the DuraTracker contains O-rings for the connectors and desiccant cartridge, two hydrophobic filters, a one-pound container of indicating silica gel desiccant, a container of lubricant, and gaskets for the battery and desiccant caps. You can order maintenance kits by contacting Teledyne ISCO's WEB store (<https://store.teledyneisco.com/>). Contact information for Teledyne ISCO's Customer Service Department can be found in Appendix A.3.1.

### 5.3 Battery Maintenance

Input voltage can be monitored while you are connected to the DuraTracker through Flowlink. The DuraTracker can also record input voltage readings to closely track power consumption. Battery discharge rates vary widely depending on the system's configuration and its operating environment. Batteries should be replaced according to the instructions in Section 2.6.

Primary cell or non-rechargeable batteries should always be replaced with new batteries.

The DuraTracker uses a CR2032 Lithium coin cell battery for backup. This battery should be replaced every 10 years.

#### 5.3.1 Battery Usage

The DuraTracker unit is equipped with two battery banks; however, it can operate using a single bank.

**✓ Note**

A 360 Laserflow will always use the battery banks in parallel.

Generally, when both battery banks are installed, the unit uses them in parallel when they both have either a high (>12.3 volts) or a low (<9.4 volts) state of charge (SoC). Otherwise, the unit uses only one of the banks.

A power cycle at any time will cause the DuraTracker unit to switch to the battery bank with the highest remaining voltage.

A DuraTracker unit switches between parallel and single-bank battery usage to extend battery life while providing itself with adequate power. For example, the unit will switch to parallel bank usage whenever it detects a high SoC in both battery banks, because that behavior will reduce battery losses from self-discharge over time.

Understanding the DuraTracker unit's battery bank switching behavior can help you better decide when to replace its batteries.

### 5.3.2 Battery Usage Examples

*Fully-charged battery banks running in parallel.*

1. In this example, both battery banks have a high SoC (>12.3 V), so they run together in parallel at first.

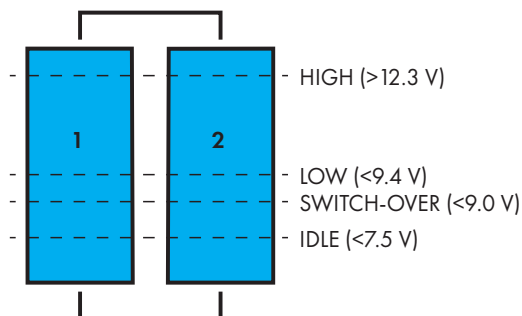

2. Battery bank 1 has dropped below the high SoC.<sup>1</sup> At that point, the DuraTracker begins to use a single battery bank. In this example, it uses bank 2 because that is the one with the highest remaining voltage. (Bank 1 would have been chosen instead if it had the higher voltage.)

*Switching to the highest bank just as the other falls below a high SoC.*

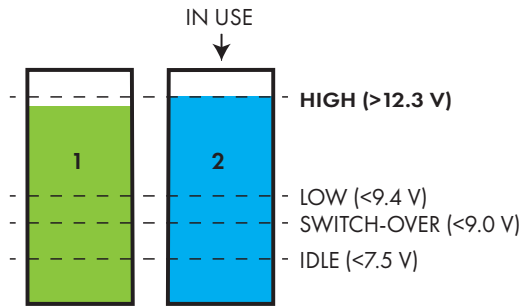

3. The DuraTracker will continue to run from that single battery bank until its voltage falls below the switch-over threshold (<9.0 V).

*Continuing to use a low-charged bank while both are above switch-over.*

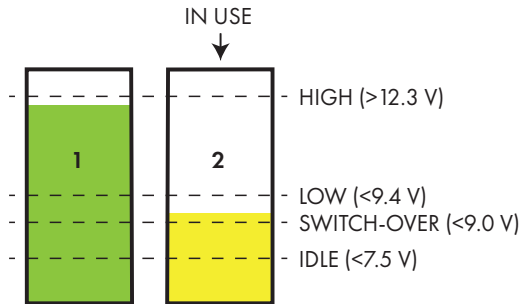

1. Actually, with the exception of idle mode, each battery threshold has a total hysteresis of 0.20 volts. For example, at the high state of charge threshold, battery switching occurs between 12.4 volts and 12.2 volts. This behavior prevents frequent battery banks switching, thus improving battery life.

- Battery bank 2 has fallen below the switch-over threshold. At this point, the DuraTracker unit detects that battery bank 1 has a higher remaining charge, so it switches to that bank.

*Switching to a bank when the other is below the switch-over threshold.*

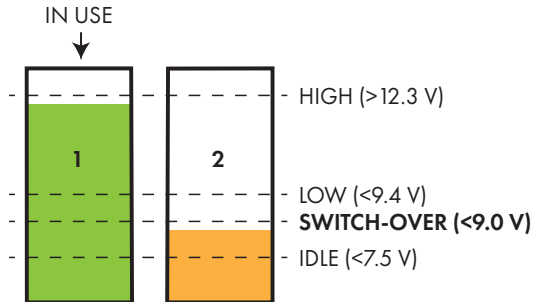

- Battery bank 2 is replaced. But even though bank 2 has the highest SoC, the DuraTracker unit continues to run from bank 1. It will continue to do so until bank 1 reaches the switch-over threshold.

*Adding a fresh battery bank while the other is above the switch-over threshold*

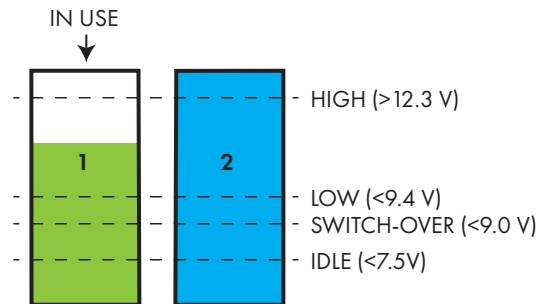

- Bank 1 has reached the low SoC threshold (9.4 V). If battery bank 2 was not replaced (as shown in the previous instance), it is well below the low SoC. With both banks low, the DuraTracker unit returns to parallel mode.

*Running in parallel mode when both banks are low.*

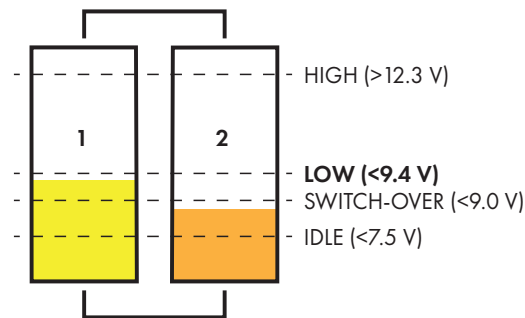



- Possibly, battery bank 1 is replaced with a fresh bank that is above the low SoC threshold. In this case, the DuraTracker unit uses only bank 1 until it too falls below the switch-over threshold. (Compare to example 5, where both banks are still above that threshold.)

*Switching to a fresh battery bank when the other is below the switch-over threshold.*

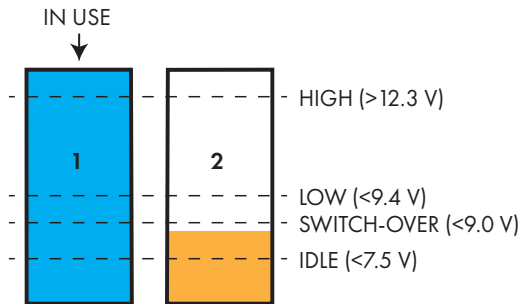

- Or, possibly, neither battery is replaced, and both voltages drop below the switch-over threshold (9.0 V). The DuraTracker unit then enters Limp mode, as explained below.

*Running battery banks parallel in Limp mode.*

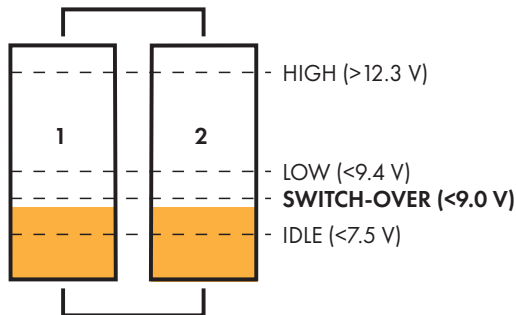

- Eventually, both voltages drop could below the idle threshold (7.5 V). The DuraTracker unit then enters Idle mode, as explained below.

*Running battery banks parallel in Idle mode.*

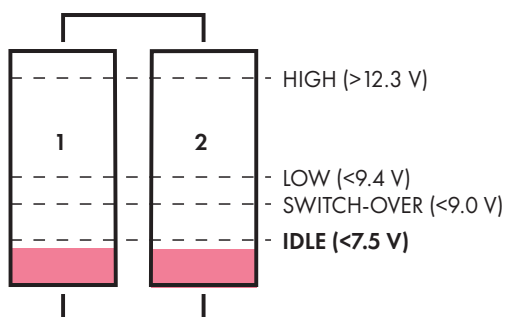

**Limp mode.** When both battery bank voltages drop below the 9.0 V (9.2 v in single batter bank) switch-over threshold, the DuraTracker unit will enter Limp mode, in which modem and Bluetooth functions are unavailable.

**Idle mode.** When both battery bank voltages drop below the 7.5 V, idle threshold, the DuraTracker unit will enter Idle mode. At that point, the DuraTracker ceases all functions and enters an extended low-power sleep mode, only waking up to check the battery bank voltages once a minute. The DuraTracker will only return to normal operation if at least one battery bank voltage is detected to exceed the low state of charge threshold.

## 5.4 Desiccant Maintenance

The DuraTracker uses desiccant to protect the internal components of the device from moisture damage. Each DuraTracker utilizes two desiccant cartridges, as shown in Figure 5-1.



Figure 5-1 Desiccant cartridge locations

The desiccant cartridge “A” is used to remove moisture from the reference air utilized by the sensor and electronics box. This prevents moisture from plugging the reference line, which would result in the sensor reporting erroneous level readings. The desiccant cartridge “B” is used to remove moisture from the battery box.

The cartridges are filled with silica gel beads that will indicate when they are saturated. Under dry conditions, the beads are orange in color. As the desiccant becomes saturated, the beads turn green. If the entire length of the desiccant cartridge turns green, the unit is no longer adequately protected. Replace the desiccant before the entire length of the desiccant cartridge turns green.

#### 5.4.1 Replacing Desiccant

The desiccant is contained within the cartridge located between the battery banks. To remove the cartridge, unscrew the cap 1/4 turn counter-clockwise, and slide the cartridge out of the unit. The clear tube reveals the silica gel desiccant inside. To replace the desiccant:

1. Hold the cartridge upright with the cap at the top.
2. Push the cap off of the cartridge with thumb.



Figure 5-2 Removal of Desiccant Cartridge Cap

3. Empty the saturated silica gel desiccant beads or granules into a separate container.
  - a. For instructions on how to reactivate saturated silica gel desiccant, see Section 5.4.2.
4. Fill the tube with new or reactivated silica gel desiccant.
5. Press the cap back onto the cartridge.
6. Slide the cartridge into the DuraTracker battery compartment, and tighten the cap 1/4 clockwise to seal the cartridge in place.

#### 5.4.2 Reactivating Desiccant

Once saturated, silica gel desiccant can no longer suitably protect the DuraTracker from moisture. The silica gel desiccant can be reactivated as described below:

1. Pour the saturated silica gel desiccant into a heat resistant container.

 **CAUTION**

Do not heat the silica gel desiccant cartridge assembly. It will melt.

2. Heat the desiccant in a vented convection oven at 212 to 350° F (100 to 175° C) for two to three hours, or until the orange color returns.
3. Remove the desiccant from the oven and allow it to cool.
4. Store the reactivated desiccant in an air-tight container until it is ready for use.

 **CAUTION**

It has been reported that the silica gel desiccant may produce irritating fumes when heated. Although Teledyne ISCO has not been able to reproduce these reports, it is recommended that you always reactivate desiccant in a well-ventilated room and use the recommended temperature range. As an added precaution, it is recommended that you leave the room while the reactivation process takes place.

 **Note**

The silica gel desiccant may lose its ability to remove moisture after several reactivations. This may result in more frequent maintenance requirements. If the desiccant becomes ineffective, replace it with new desiccant.

## 5.5 Hydrophobic Filter Maintenance

The DuraTracker is equipped with a hydrophobic filter which blocks water from the desiccant cartridge if the DuraTracker is subjected to extremely humid or submerged conditions. Any amount of liquid water will plug the filter and restrict access to sensitive components. If this occurs, the filter must be removed, rinsed with clean water, and allowed to dry. Alternatively, the filter may need to be replaced.

To remove the hydrophobic filter, use a 5/8" or 16 mm socket wrench to gently unscrew the filter from the DuraTracker. Then, gently screw the replacement filter into place.



Figure 5-3 Replacing the hydrophobic filter

If the hydrophobic filter requires frequent replacement, consider relocating the unit to an area that is more suitably protected.

 **Note**

Unsteady TIENet 350 AV Level sensor readings are often an indication that the hydrophobic filter may be plugged.

## 5.6 Cleaning the DuraTracker

Before cleaning the module, ensure that all protective connector caps are in place. The housing of the DuraTracker should be cleaned with a mild detergent and warm water.

The cables and outer surfaces of the TIENet sensors may also be cleaned with a mild detergent and warm water.

## 5.7 Servicing the DuraTracker

The internal components of the DuraTracker are not user-serviceable. If the DuraTracker requires repair, contact Teledyne ISCO's Water Product support. Contact information for Teledyne ISCO can be found in Appendix A.3.1.

Corresponding with a Teledyne ISCO technical service representative often resolves problems with the unit without the need to return the item. If the problem cannot be resolved, you will be issued a Return Merchandise Authorization (RMA) and instructions on how to return the unit to the factory.

## 5.8 Diagnostics

Many functions of the DuraTracker generate a diagnostic file. Diagnostic files can often be used to isolate a problem so it can be adequately understood and fixed.

To view a diagnostic file, connect to the site using Flowlink. Within the MEASUREMENT tab of the problematic function, click the DIAGNOSTICS button. This prompts the DuraTracker to generate a diagnostic file which is accessed by Flowlink as a text report.

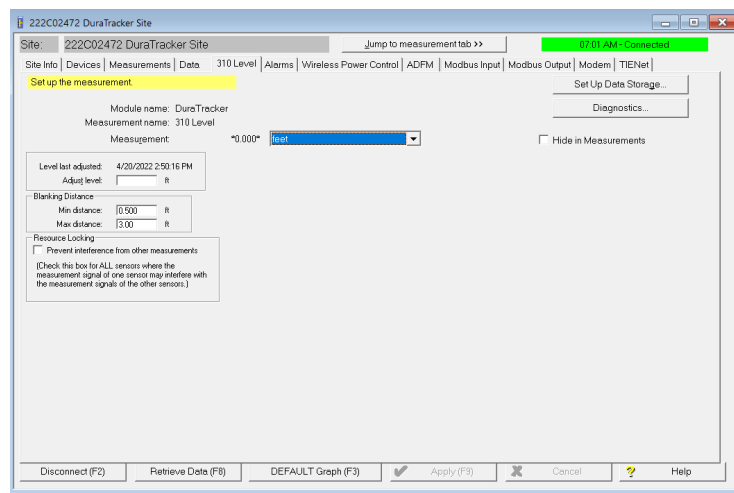

Figure 5-4 Retrieving diagnostic files manually

Diagnostic files can also be retrieved while Flowlink retrieves site data. The most recent diagnostic files are kept in Flowlink's database where they can be accessed at a later date. To enable this feature, open UTILITIES > OPTIONS from the menu and check "Retrieve data gets text reports" on the DuraTracker tab.

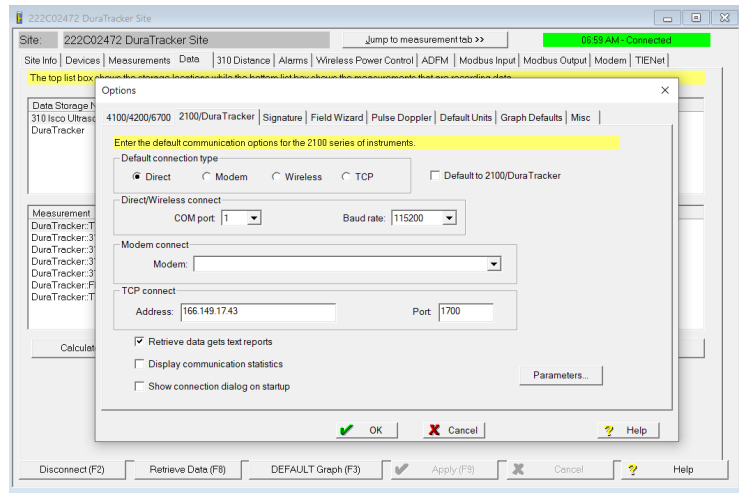

Figure 5-5 Retrieving diagnostic files automatically

# DuraTracker®

## Appendix A

### A.1 Replacement Parts

### A.2 Optional Equipment and Accessories

#### Ordering Information

Options and accessories can be purchased by visiting the Teledyne ISCO online store at [store.teledyneisco.com](http://store.teledyneisco.com).

#### DuraTracker Logger Accessories

#### A.2.1 Cables and Accessories

USB communication cable (6ft) .....	480-2946-06
Power/Modbus communication cable (25ft) .....	60-4804-023
Din rail mount DC power supply, Input 115-230 VAC 50/60 Hz, Output 12 VDC 1.5A .....	340-0002-18
TIENet Cable with TIENet plug on one side cut to length.....	60-4804-071
Silica gel desiccant, 1.0-lb container .....	60-2004-233
DuraTracker maintenance kit .....	60-4804-021
TIENet 'Y' connection cable .....	60-4304-066
TIENet Expansion Box w/ 10 ft cable .....	60-4307-023
TIENet Expansion Box w/ 10 ft cable and reference air support .....	60-4357-018
Ex Reference Air Box w/ 10m cable.....	68-4800-025
Ex Reference Air Box w/ 23m cable.....	68-4800-026
Ex Reference Air Box w/ cut to length cable.....	68-4800-027
Spreader bar for suspension of sensor or flow meter in manhole shaft .....	60-3004-110

#### A.2.2 Battery Options

Spiral wound Lithium Thionyl Chloride D cell battery (low temp applications).....	340-9036-00
Lithium Thionyl Chloride battery holder (DuraTracker ONLY).....	60-4804-026
Lantern battery holder (DuraTracker ONLY).....	60-4804-025
Hazloc D cell battery holder .....	60-4804-024

#### A.2.3 301 pH/Temperature Device Ending in TIENet Plug

*Includes combination pH probe with built-in exposed temperature probe and 25 ft. probe cable and one package of each buffer and rinse solution for probe calibration*

10 m cable* .....	60-4307-070
23 m cable* .....	60-4307-071
Cut-to-length cable* .....	60-4307-072

\* Cable lengths from Signature to TIENet 301 device

**A.2.4 306 Sampler Interface  
Cable with Connection  
Ending in TIENet Plug**

306 Sampler Interface w/ connector and 10m (32.8 ft) cable .....	60-4304-076
306 Sampler Interface w/ connector and 23 m (75 ft) cable .....	60-4304-077
306 Sampler Interface w/ connector and CTL cable.....	60-4304-078

**A.2.5 310 Ex Ultrasonic Level  
Sensor with  
Connection Ending in  
TIENet Plug**

310 Ex Ultrasonic sensor w/ connector and 10m cable .....	60-4314-009
310 Ex Ultrasonic sensor w/ connector and 23m cable .....	60-4314-011
310 Ex Ultrasonic sensor w/ connector Cut-to-length* .....	60-4314-013

\* Cable lengths can go up to 150 m with an expansion box.

**A.2.6 360 LaserFlow Velocity  
Sensor with  
Connection Ending in  
TIENet Plug**

360 Laserflow sensor w/ connector and 10m cable .....	68-2160-061 – ISCO3098
360 Laserflow sensor w/ connector and 23m cable .....	68-2160-061 – ISCO3099
360 Laserflow sensor w/ connector Cut-to-length*.....	60-4364-077

\* Cable lengths can go up to 150 m

360 Laserflow sensor w/ connector and 10m cable +USNC .....	68-2160-061 – ISCO3100
360 Laserflow sensor w/ connector and 23m cable +USNC .....	68-2160-061 – ISCO3101
360 Laserflow sensor w/ connector Cut-to-length* +USNC.....	60-4364-079

\* Cable lengths can go up to 150 m



**A.2.7 360 LaserFlow Ex  
Velocity Sensor with  
Connection Ending in  
TIENet Plug**

360 Laserflow Ex sensor w/ connector and 10m cable .....	60-4364-095
360 Laserflow Ex sensor w/ connector and 23m cable .....	60-4364-098
360 Laserflow Ex sensor w/ connector Cut-to-length* .....	60-4364-099

\* Cable lengths can go up to 33 m

360 Laserflow Ex sensor w/ connector and 10m cable +USNC.....	60-4364-103
360 Laserflow Ex sensor w/ connector and 23m cable +USNC.....	60-4364-104
360 Laserflow Ex sensor w/ connector Cut-to-length* +USNC .....	60-4364-105

\* Cable lengths can go up to 33 m

**A.2.8 350 Ex Area Velocity  
Sensor with  
Connection Ending in  
TIENet Plug**

350 Ex Area Velocity Surcharge sensor .....	60-4854-012
350 Ex Area Velocity sensor with connector and 10m cable.....	60-4854-013
350 Ex Area Velocity sensor with connector and 23m cable.....	60-4854-014
350 Ex Area Velocity sensor with connector Cut-to-length*.....	60-4854-016

\* Cable lengths can go up to 30 m

**A.2.9 Modems**

*DuraTracker (cannot be  
used in DuraTracker Ex)*

LTE Digital cellular modem kit (North America) (Cellular service not included) .....	60-4807-013
LTE Digital cellular modem kit (Europe) (Cellular service not included) .....	60-4807-014

**A.3 Company Contact  
Information**

**A.3.1 Customer Service  
Department**

Teledyne ISCO  
Technical Service Dept.  
4700 Superior Street  
Lincoln, NE 68504 USA

Phone: (866) 298-6174  
(402) 464-0231

FAX:(402) 465-3022

E-mail: [iscowatersupport@teledyne.com](mailto:iscowatersupport@teledyne.com)



# DuraTracker<sup>®</sup>

---

## *Appendix B Material Safety Data Sheets*

### **B.1 Safety**

This appendix provides Material Safety Data Sheets for the desiccant used by the DuraTracker Logger.

Teledyne ISCO cannot guarantee the accuracy of the data. Specific questions regarding the use and handling of the products should be directed to the manufacturer listed on the MSDS.

SORB-IT<sup>®</sup> is a registered trademark of N. T. Gates Company.

MATERIAL SAFETY DATA SHEET



sSORB®



Health	1
Fire	0
Reactivity	0
Personal Protection	E

Section 1: CHEMICAL PRODUCT & COMPANY IDENTIFICATION

<b>Product Name:</b> sSORB®	<b>Supplier:</b> Interra Global Corporation
<b>Chemical Name:</b> Yellow Indicating Silica Gel	371 Edgemont Lane
<b>Synonyms:</b> Orange Indicating Silica Gel	Park Ridge, IL 60068
	USA
<b>Emergency Assistance</b>	
USA + 1.847.292.8600	Telephone: + 1.847.292.8600
Outside USA + 1.847.292.8600	Fax: + 1.847.292.8601

Section 2: COMPOSITION & INFORMATION ON INGREDIENTS

**CAS Numbers:** 1343-98-2, 77-09-8  
**Molecular Formula:** SiO<sub>2</sub> · nH<sub>2</sub>O + C<sub>20</sub>H<sub>14</sub>O<sub>4</sub>

Section 3: HAZARDS IDENTIFICATION

**Potential Health Effects**

**Inhalation:** May cause dryness and irritation to mucous membranes, nose and throat. Symptoms may include coughing, sore throat, and wheezing.

**Ingestion:** No adverse effects expected.

**Skin Contact:** May cause irritation with dryness and abrasion.

**Eye Contact:** May cause irritation, redness and pain.

**Chronic Exposure:** Repeated exposure may cause symptoms similar to those listed for acute effects. Synthetic amorphous silica does not produce silicosis.

Section 4: FIRST AID MEASURES

**Eye Contact:** Check for and remove any contact lenses. In case of contact, immediately flush eyes with plenty of water for at least 15 minutes. Get medical attention if irritation occurs.

**Skin Contact:** Wash with soap and water. Cover the irritated skin with an emollient. Get medical attention if irritation develops.

**Ingestion:** Give several glasses of water to drink to dilute. If large amounts were swallowed, get medical advice.

**Inhalation:** If inhaled, remove to fresh air. If breathing is difficult, get medical attention.

Section 5: FIRE & EXPLOSION DATA

**Fire:** Not considered to be a fire hazard.

**Explosion:** Not considered to be an explosion hazard.

**Fire Fighting Media and Instructions:** Use any means suitable for extinguishing surrounding fire.

**Special Remarks:** Use protective clothing and breathing equipment appropriate for surrounding fire.

INTERRA Global Corporation

msds sSORB



p1

**MATERIAL SAFETY DATA SHEET**

**Section 6: ACCIDENTAL RELEASE MEASURES**

**Small Spill:** Use appropriate tools to put the spilled solid in a convenient waste disposal container. Use respiratory protection and eye protection.

**Large Spill:** Use a shovel to put the material into a convenient waste disposal container. Vacuuming or wet sweeping may be used to avoid dust dispersal. Use respiratory protection and eye protection.

**Section 7: HANDLING & STORAGE**

**Storage:** Keep container tightly closed. Suitable for any general chemical storage area. Containers of this material may be hazardous when empty since they retain product residues (dust, solids); observe all warnings and precautions listed for the product.

**Section 8: EXPOSURE CONTROLS / PERSONAL PROTECTION**

**Engineering Controls:** Use process enclosures, local exhaust ventilation, or other engineering controls to keep airborne levels below recommended exposure limits. If user operations generate dust, fume or mist, use ventilation to keep exposure to airborne contaminants below the exposure limit.

**Personal Protection:** Safety glasses. Lab coat. Respirator (NIOSH Approved). Gloves.

**Section 9: PHYSICAL & CHEMICAL PROPERTIES**

<b>Physical state:</b>	Solid	<b>Boiling Point:</b>	2230C (4046F)
<b>Color:</b>	Yellow/Orange-Dry:Green-Saturated	<b>Melting Point:</b>	1610C (2930F)
<b>Odor:</b>	Odorless	<b>Vapor Pressure:</b>	Not applicable.
<b>Solubility:</b>	Insoluble	<b>Vapor Density:</b>	Not applicable.
<b>Specific Gravity:</b>	2.1 (Water=1)	<b>Evaporation Rate:</b>	Not available.
<b>pH :</b>	3 - 8 (in 5% slurry)	<b>% Volatiles by volume @ 21C (70F):</b>	0

**Section 10: STABILITY & REACTIVITY**

**Stability:** The product is stable.

**Hazardous Decomposition Products:** Oxides of carbon and silicon may be formed when heated.

**Hazardous Polymerization:** Will not occur.

**Incompatibility with powerfull oxidizers:** Reacts with hydrogen flouride, fluorine, oxygen difluoride, chlorine trifluoride, strong acids, strong bases, and oxidizers.

**Conditions to Avoid:** Moisture, extreme heat, and incompatibles.

**Section 11: TOXICOLOGICAL INFORMATION**

**Routes of Entry:** Absorbed through skin. Eye contact. Inhalation. Ingestion.

**Toxicity to Animals:**

**LD50:** Not available.

**LC50:** Not available.

**Section 12: ECOLOGICAL INFORMATION**

**Ecotoxicity:** This material is not expected to be toxic to aquatic life.

**MATERIAL SAFETY DATA SHEET**

**Section 13: DISPOSAL CONSIDERATIONS**

**Waste Disposal:** Waste must be disposed of in accordance with federal, state and local environmental control regulations.

**Section 14: TRANSPORT INFORMATION**

**DOT Classification:** Not a DOT controlled material (United States).  
**Identification:** Not applicable.

**Section 15: OTHER REGULATORY INFORMATION**

**HMIS (U.S.A.):**

**Health Hazard:** 1  
**Fire Hazard:** 0  
**Reactivity:** 0  
**Personal Protection:** E

**National Fire Protection Association (U.S.A.):**

**Health:** 1  
**Flammability:** 0  
**Reactivity:** 0

**Section 16: OTHER INFORMATION**

**References:** Not available.  
**Other Special Considerations:** Not available.

**Created:** 04/03/2009 11:20 AM  
**Last Updated:** 03/25/2010 10:40 AM

The purpose of this Safety Data Sheet is to describe the products in terms of their safety requirements. The information above is believed to be accurate and represents the best information currently available to us. However, we make no warranty of merchantability or any other warranty, express or implied, with respect to such information, and we assume no liability resulting from its use. Users should make their own investigations to determine the suitability of the information for their particular purposes. In no event shall Interra Global Corporation be liable for any claims, losses, or damages of any third party or for lost profits or any special, indirect, incidental, consequential or exemplary damages, howsoever arising, even if Interra Global Corporation has been advised of the possibility of such damages.



## MATERIAL SAFETY DATA SHEET



Date Issued: 07/06/2004  
MSDS No: 5008  
Date Revised: 11/28/2011  
Revision No: 3

Desi Pak®

### 1. PRODUCT AND COMPANY IDENTIFICATION

**PRODUCT NAME:** Desi Pak®  
**GENERAL USE:** Desiccant

**MANUFACTURER**

Süd-Chemie Performance Packaging  
101 Christine Drive  
Rio Grande Industrial Park  
Belen, NM 87002  
**Customer Service:** 505-864-6691

**24 HR. EMERGENCY TELEPHONE NUMBERS**

**CHEMTREC :** (800) 424 - 9300  
**Outside the U.S. Call Collect :** 001 (703) 527-3887

### 2. HAZARDS IDENTIFICATION

**EMERGENCY OVERVIEW**

**PHYSICAL APPEARANCE:** Performance packaging product, size and type vary.

**IMMEDIATE CONCERNS:** Poses little or no immediate hazard.

**POTENTIAL HEALTH EFFECTS**

**EYES:** Route of exposure unlikely. Dust may cause a mechanical irritation which can scratch the eye.

**SKIN:** No adverse effects expected.

**INGESTION:** Non-toxic by ingestion. Packets or canisters may pose a choking hazard. Keep away from children and pets.

**INHALATION:** Route of exposure unlikely. This material is normally packaged and contained in a pouch, bag or canister. If the container is opened, prolonged or repeated inhalation of high dust concentrations may cause lung damage.

### 3. COMPOSITION / INFORMATION ON INGREDIENTS

INGREDIENT(S)	CAS	Wt.%
Pouch, Bag, Canister, Stopper, or Cap		1 - 75
Clay	1302-78-9	25 - 99
Silica, quartz	14808-60-7	<0.5

See Section 8 for Exposure Limits

### 4. FIRST AID MEASURES

**EYES:** Do not rub eyes. Flush with lukewarm, gently flowing water for 5 minutes or until the particle/dust is removed, while holding the eyelid(s) open. Obtain medical attention.

**SKIN:** Wash with soap and water.



**Desi Pak®**

**INGESTION:** Normally not needed. If large quantities are ingested, call your local Poison Control Center (1-800-222-1222 in the U.S.).  
**INHALATION:** Normally not needed. If exposed to excessive levels of dust or fumes, remove to fresh air and seek medical attention of cough or other symptoms develop or persist.

**5. FIRE FIGHTING MEASURES**

**FLASHPOINT AND METHOD:** Material is not flammable  
**EXTINGUISHING MEDIA:** Use extinguishing agent applicable to surrounding fire.  
**FIRE FIGHTING PROCEDURES:** As in any fire, wear self-contained breathing apparatus operated in pressure-demand mode, (NIOSH approved or equivalent) and full protective gear.

**6. ACCIDENTAL RELEASE MEASURES**

**SMALL SPILL:** No special precautions required.  
**LARGE SPILL:** With shovel or scoop, place material into appropriate container.

**7. HANDLING AND STORAGE**

**HANDLING:** Use of proper hygiene practices in the workplace is recommended.  
**STORAGE:** Store in a dry area.

**8. EXPOSURE CONTROLS / PERSONAL PROTECTION**

EXPOSURE GUIDELINES					
HAZARDOUS COMPONENTS					
EXPOSURE LIMITS					
OSHA PEL					
ACGIH TLV					
Chemical Name		ppm	mg/m <sup>3</sup>	ppm	mg/m <sup>3</sup>
Clay	TWA	[1]	[1]	[1]	[1]
Silica, quartz	TWA	[2]	[2]	[3]	0.025 [3]
<b>OSHA TABLE COMMENTS:</b> 1. Exposure limits not established. 2. Total Dust = (30 mg/m <sup>3</sup> )/(%SiO <sub>2</sub> +2) 3. Respirable					

**ENGINEERING CONTROLS:** If user operations generate dust, fume or mist, use ventilation to keep exposure to airborne contaminants below the exposure limit.

**PERSONAL PROTECTIVE EQUIPMENT**

**EYES AND FACE:** Follow facility guidelines.

**SKIN:** Use of proper hygiene practices in the workplace is recommended.

**RESPIRATORY:** Use local exhaust if dusting occurs. Good general ventilation is adequate in the absence of dusts.

**COMMENTS:** All inert or nuisance dusts, whether mineral, inorganic, or organic, not listed specifically by substance name are covered by the Particulates Not Otherwise Regulated (PNOR) limit which is 5 mg/m<sup>3</sup> for respirable fraction and 15 mg/m<sup>3</sup> for total dust. ACGIH exposure guidelines of less than 3 mg/m<sup>3</sup> (respirable) and 10 mg/m<sup>3</sup> (inhalable) have been established for particles (insoluble/poorly soluble) not otherwise specified (PNOS).

**Desi Pak®**

**9. PHYSICAL AND CHEMICAL PROPERTIES**

**PHYSICAL STATE:** Solid  
**ODOR:** None  
**pH:** Not Determined  
**PERCENT VOLATILE:** None  
**VAPOR PRESSURE:** Not Applicable  
**VAPOR DENSITY:** Not applicable.  
**EVAPORATION RATE:** Not Applicable  
**VISCOSITY:** Not Applicable  
**OXIDIZING PROPERTIES:** None

**10. STABILITY AND REACTIVITY**

**STABLE:** Yes  
**HAZARDOUS POLYMERIZATION:** No

**11. TOXICOLOGICAL INFORMATION**

**ACUTE**

Chemical Name	ORAL LD <sub>50</sub> (rat)	DERMAL LD <sub>50</sub> (rabbit)	INHALATION LC <sub>50</sub> (rat)
Clay	> 5000 gm/kg(b.w.)		> 200 mg/L/1H
Silica, quartz	500 gm/kg(b.w.)	No Data Available	No Data Available

**CARCINOGENICITY**

Chemical Name	NTP Status	IARC Status	OSHA Status
Clay	Not listed.	Not listed.	Not listed.
Silica, quartz	Known Carcinogen	Group I	Not listed.

**SENSITIZATION:** Not sensitizing

**GENERAL COMMENTS:** Crystalline silica present is contained within a pouch, canister or bag. No exposure to airborne particles of respirable size is expected under normal conditions of use.

**12. ECOLOGICAL INFORMATION**

**ENVIRONMENTAL DATA:** Low hazard for usual industrial or commercial handling.

**CHEMICAL FATE INFORMATION:** This material is of mineral origin. It is not biodegradable.

**13. DISPOSAL CONSIDERATIONS**

**DISPOSAL METHOD:** This product, if discarded as sold, is not a Federal RCRA hazardous waste. Processing, use or

**Desi Pak®**

contamination of this product may change the waste management options. State and local disposal regulations may differ from federal disposal regulations.

**14. TRANSPORT INFORMATION**

**DOT (DEPARTMENT OF TRANSPORTATION)**

**PROPER SHIPPING NAME:** Not regulated

**ROAD AND RAIL (ADR/RID)**

**PROPER SHIPPING NAME:** Not regulated

**AIR (ICAO/IATA)**

**SHIPPING NAME:** Not regulated

**VESSEL (IMO/IMDG)**

**SHIPPING NAME:** Not regulated

**CANADA TRANSPORT OF DANGEROUS GOODS**

**SHIPPING NAME:** Not regulated

**15. REGULATORY INFORMATION**

**UNITED STATES**

**SARA TITLE III (SUPERFUND AMENDMENTS AND REAUTHORIZATION ACT)**

**FIRE:** No **PRESSURE GENERATING:** No **REACTIVITY:** No **ACUTE:** No **CHRONIC:** Yes

**313 REPORTABLE INGREDIENTS:** Not listed.

**CERCLA (COMPREHENSIVE RESPONSE, COMPENSATION, AND LIABILITY ACT)**

**CERCLA REGULATORY:** Not listed.

**TSCA (TOXIC SUBSTANCE CONTROL ACT)**

**TSCA STATUS:** All components are listed on the TSCA Inventory or are excluded or exempt.

**REGULATIONS**

**STATE REGULATIONS:** California

**CALIFORNIA PROPOSITION 65:** This product does not contain chemical(s) known to the state of California to cause cancer, birth defects, or reproductive harm.

Crystalline silica present is contained within a pouch, canister or bag. There is no exposure to airborne particles of respirable size under normal conditions of use.

Chemical Name	Wt. %	Listed
Silica, quartz	<0.5	Cancer

**RCRA STATUS:** This product, if discarded as sold, is not a Federal RCRA hazardous waste. Processing, use or contamination of this product may change the waste management options. State and local disposal regulations may differ from federal disposal regulations.

**CANADA**

**WHMIS HAZARD SYMBOL AND CLASSIFICATION**

Does not meet classification criteria pursuant to the Canadian Hazardous Products Act.

**WHMIS (WORKPLACE HAZARDOUS MATERIALS INFORMATION SYSTEM):** This MSDS has been prepared according to the hazard criteria of the Controlled Products Regulations (CPR) and the MSDS contains all of the information required by the CPR.

**CANADA INGREDIENT DISCLOSURE LIST:** Contains component(s) listed on the Canadian Hazardous Products Act Ingredient Disclosure List.

**CANADIAN ENVIRONMENTAL PROTECTION ACT:** All ingredients are listed on the Canadian Domestic Substances List inventory.

**Desi Pak®**

**EUROPEAN COMMUNITY  
EEC LABEL SYMBOL AND CLASSIFICATION**

Not classified as dangerous

**16. OTHER INFORMATION**

**APPROVED BY:** Prepared and approved by SHE Dept. Sud-Chemie Inc.

**INFORMATION CONTACT:** E-mail - MSDS\_US@sud-chemie.com

**REVISION SUMMARY:** This MSDS replaces the 01/21/2009 MSDS. Revised: **Section 1:** INFORMATION CONTACT. **Section 16:** HMIS RATING ( HEALTH, PHYSICAL HAZARD, HMIS RATINGS NOTES, CHRONIC ).

HMIS RATING	
HEALTH	* 1 0
PHYSICAL HAZARD	0
PERSONAL PROTECTION	<input type="checkbox"/>

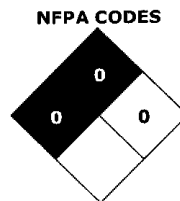

**HMIS RATINGS NOTES:** Personal Protection should be determined based on workplace conditions.

**MANUFACTURER DISCLAIMER:** The information presented herein is believed to be accurate but is not warranted. Recipients are advised to confirm in advance that the information is current, applicable and suitable to their circumstances.